



*Empowered lives.
Resilient nations.*

REQUEST FOR PROPOSALS

PARLIAMENT OF UGANDA / UNITED NATIONS DEVELOPMENT PROGRAMME (UNDP)

**SUPPLY AND INSTALLATION OF SOUND TREATMENT,
ACOUSTICS MATERIALS AND STUDIO ELECTRICAL
INSTALLATIONS**



*Empowered lives.
Resilient nations.*

United Nations Development Programme
November, 2017

Section 1. Letter of Invitation

Kampala, Uganda
November 30, 2017

**SUPPLY AND INSTALLATION OF SOUND TREATMENT,
ACOUSTICS MATERIALS AND STUDIO ELECTRICAL
INSTALLATIONS**

Dear Mr/Ms

The United Nations Development Programme (UNDP) hereby invites you to submit a Proposal to this Request for Proposal (RFP) for the above-referenced subject.

This RFP includes the following documents:

- Section 1 – This Letter of Invitation
- Section 2 – Instructions to Proposers (including Data Sheet)
- Section 3 – Scope of work
- Section 4 – Proposal Submission Form
- Section 5 – Documents Establishing the Eligibility and Qualifications of the Proposer
- Section 6 – Technical Proposal Form
- Section 7 – Financial Proposal Form
- Section 8 – Contract for Professional Services, including General Terms and Conditions

Your offer, comprising of a Technical and Financial Proposal, in separate sealed envelopes, should be submitted in accordance with Section 2.

You are kindly requested to submit an acknowledgment letter to UNDP to the following address:

United Nations Development Programme
Plot 11 Yusuf Lule Road, Nakasero
Kampala Uganda

Attention: Procurement Office

Email: tenders.kampala@undp.org

The letter should be received by UNDP no later than **8th December 2017 at 10:00am through the above email.**

The same letter should advise whether your company intends to submit a Proposal. If that is not the case, UNDP would appreciate your indicating the reason, for our records.

Should you require further clarifications, kindly communicate with the contact person identified in the attached Data Sheet as the focal point for queries on this RFP.

UNDP looks forward to receiving your Proposal and thanks you in advance for your interest in UNDP procurement opportunities.

Yours sincerely,

Thomas Ole-Kuyan
Deputy Country Director-Operations
30th November, 2017

Section 2: Instruction to Proposers¹

Definitions

- a) “Contract” refers to the agreement that will be signed by and between the UNDP and the successful proposer, all the attached documents thereto, including the General Terms and Conditions (GTC) and the Appendices.
- b) “Country” refers to the country indicated in the Data Sheet.
- c) “Data Sheet” refers to such part of the Instructions to Proposers used to reflect conditions of the tendering process that are specific for the requirements of the RFP.
- d) “Day” refers to calendar day.
- e) “Government” refers to the Government of the country that will be receiving the services provided/rendered specified under the Contract.
- f) “Instructions to Proposers” (Section 2 of the RFP) refers to the complete set of documents that provides Proposers with all information needed and procedures to be followed in the course of preparing their Proposals
- g) “LOI” (Section 1 of the RFP) refers to the Letter of Invitation sent by UNDP to Proposers.
- h) “Material Deviation” refers to any contents or characteristics of the proposal that is significantly different from an essential aspect or requirement of the RFP, and: (i) substantially alters the scope and quality of the requirements; (ii) limits the rights of UNDP and/or the obligations of the offeror; and (iii) adversely impacts the fairness and principles of the procurement process, such as those that compromise the competitive position of other offerors.
- i) “Proposal” refers to the Proposer’s response to the Request for Proposal, including the Proposal Submission Form, Technical and Financial Proposal and all other documentation attached thereto as required by the RFP.
- j) “Proposer” refers to any legal entity that may submit, or has submitted, a Proposal for the provision of services requested by UNDP through this RFP.
- k) “RFP” refers to the Request for Proposals consisting of instructions and references prepared by UNDP for purposes of selecting the best service provider to perform the services described in the Terms of Reference.
- l) “Services” refers to the entire scope of tasks and deliverables requested by UNDP under the RFP.

¹ Note: this Section 2 - Instructions to Proposers shall not be modified in any way. **Any necessary changes to address specific country and project information, shall be introduced only through the Data Sheet..**

- m) *“Supplemental Information to the RFP”* refers to a written communication issued by UNDP to prospective Proposers containing clarifications, responses to queries received from prospective Proposers, or changes to be made in the RFP, at any time after the release of the RFP but before the deadline for the submission of Proposals.
- n) *“Terms of Reference”* (TOR) refers to the document included in this RFP as Section 3 which describes the objectives, scope of services, activities, tasks to be performed, respective responsibilities of the proposer, expected results and deliverables and other data pertinent to the performance of the range of duties and services expected of the successful proposer.

A. GENERAL

1. UNDP hereby solicits Proposals in response to this Request for Proposal (RFP). Proposers must strictly adhere to all the requirements of this RFP. No changes, substitutions or other alterations to the rules and provisions stipulated in this RFP may be made or assumed unless it is instructed or approved in writing by UNDP in the form of Supplemental Information to the RFP.
2. Submission of a Proposal shall be deemed as an acknowledgement by the Proposer that all obligations stipulated by this RFP will be met and, unless specified otherwise, the Proposer has read, understood and agreed to all the instructions in this RFP.
3. Any Proposal submitted will be regarded as an offer by the Proposer and does not constitute or imply the acceptance of any Proposal by UNDP. UNDP is under no obligation to award a contract to any Proposer as a result of this RFP.
4. UNDP implements a policy of zero tolerance on proscribed practices, including fraud, corruption, collusion, unethical practices, and obstruction. UNDP is committed to preventing, identifying and addressing all acts of fraud and corrupt practices against UNDP as well as third parties involved in UNDP activities. (See for full description of the policies)
http://www.undp.org/content/dam/undp/library/corporate/Transparency/UNDP_Anti_Fraud_Policy_English_FINAL_june_2011.pdf and
<http://www.undp.org/content/undp/en/home/operations/procurement/protestandsanctions/>
5. In responding to this RFP, UNDP requires all Proposers to conduct themselves in a professional, objective and impartial manner, and they must at all times hold UNDP’s interest’s paramount. Proposers must strictly avoid conflicts with other assignments or their own interests, and act without consideration for future work. All Proposers found to have a conflict of interest shall be disqualified. Without limitation on the generality of the above, Proposers, and any of their affiliates, shall be considered to have a conflict of interest with one or more parties in this solicitation process, if they:
 - 5.1 Are or have been associated in the past, with a firm or any of its affiliates which have been engaged UNDP to provide services for the preparation of the design, specifications, Terms of Reference, cost analysis/estimation, and other documents to be used for the procurement of the goods and services in this selection process;

- 5.2 Were involved in the preparation and/or design of the programme/project related to the services requested under this RFP; or
- 5.3 Are found to be in conflict for any other reason, as may be established by, or at the discretion of, UNDP.

In the event of any uncertainty in the interpretation of what is potentially a conflict of interest, proposers must disclose the condition to UNDP and seek UNDP's confirmation on whether or not such conflict exists.

- 6. Similarly, the Proposers must disclose in their proposal their knowledge of the following:
 - 6.1. That they are owners, part-owners, officers, directors, controlling shareholders, or they have key personnel who are family of UNDP staff involved in the procurement functions and/or the Government of the country or any Implementing Partner receiving services under this RFP; and
 - 6.2. All other circumstances that could potentially lead to actual or perceived conflict of interest, collusion or unfair competition practices.

Failure of such disclosure may result in the rejection of the proposal or proposals affected by the non-disclosure.

- 7. The eligibility of Proposers that are wholly or partly owned by the Government shall be subject to UNDP's further evaluation and review of various factors such as being registered as an independent entity, the extent of Government ownership/share, receipt of subsidies, mandate, access to information in relation to this RFP, and others that may lead to undue advantage against other Proposers, and the eventual rejection of the Proposal.
- 8. All Proposers must adhere to the UNDP Supplier Code of Conduct, which may be found at this link: http://www.un.org/depts/ptd/pdf/conduct_english.pdf

B. CONTENTS OF PROPOSAL

9. Sections of Proposal

Proposers are required to complete, sign and submit the following documents:

- 9.1 Proposal Submission Cover Letter Form (see RFP Section 4);
- 9.2 Documents Establishing the Eligibility and Qualifications of the Proposer (see RFP Section 5);
- 9.3 Technical Proposal (see prescribed form in RFP Section 6);
- 9.4 Financial Proposal (see prescribed form in RFP Section 7);
- 9.5 Any attachments and/or appendices to the Proposal.

10. Clarification of Proposal

- 10.1 Proposers may request clarifications of any of the RFP documents no later than the date indicated in the Data Sheet (DS no. 16) prior to the proposal submission date. Any request

for clarification must be sent in writing via courier or through electronic means to the UNDP address indicated in the Data Sheet (DS no. 17).

- 10.2 UNDP shall endeavor to provide such responses to clarifications in an expeditious manner, but any delay in such response shall not cause an obligation on the part of UNDP to extend the submission date of the Proposals, unless UNDP deems that such an extension is justified and necessary.

11. Amendment of Proposals

- 11.1 At any time prior to the deadline of Proposal submission, UNDP may for any reason, such as in response to a clarification requested by a Proposer, modify the RFP in the form of a Supplemental Information to the RFP. All prospective Proposers will be notified in writing of all changes/amendments and additional instructions through Supplemental Information to the RFP and through the method specified in the Data Sheet (DS No. 18).
- 11.2 In order to afford prospective Proposers reasonable time to consider the amendments in preparing their Proposals, UNDP may, at its discretion, extend the deadline for submission of Proposals, if the nature of the amendment to the RFP justifies such an extension.

C. PREPARATION OF PROPOSALS

12. Cost

The Proposer shall bear any and all costs related to the preparation and/or submission of the Proposal, regardless of whether its Proposal was selected or not. UNDP shall in no case be responsible or liable for those costs, regardless of the conduct or outcome of the procurement process.

13. Language

The Proposal, as well as any and all related correspondence exchanged by the Proposer and UNDP, shall be written in the language (s) specified in the Data Sheet (DS No 4). Any printed literature furnished by the Proposer written in a language other than the language indicated in the Data Sheet, must be accompanied by a translation in the preferred language indicated in the Data Sheet. For purposes of interpretation of the Proposal, and in the event of discrepancy or inconsistency in meaning, the version translated into the preferred language shall govern. Upon conclusion of a contract, the language of the contract shall govern the relationship between the contractor and UNDP.

14. Proposal Submission Form

The Proposer shall submit the Proposal Submission Form using the form provided in Section 4 of this RFP.

15. Technical Proposal Format and Content

Unless otherwise stated in the Data Sheet (DS no. 28), the Proposer shall structure the Technical Proposal as follows:

- 15.1 Expertise of Firm/Organization – this section should provide details regarding management structure of the organization, organizational capability/resources, and experience of organization/firm, the list of projects/contracts (both completed and ongoing, both domestic and international) which are related or similar in nature to the requirements of the RFP, and proof of financial stability and adequacy of resources to

complete the services required by the RFP (see RFP clause 18 and DS No. 26 for further details). The same shall apply to any other entity participating in the RFP as a Joint Venture or Consortium.

- 15.2 Proposed Methodology, Approach and Implementation Plan – this section should demonstrate the Proposer’s response to the Terms of Reference by identifying the specific components proposed, how the requirements shall be addressed, as specified, point by point; providing a detailed description of the essential performance characteristics proposed; identifying the works/portions of the work that will be subcontracted; and demonstrating how the proposed methodology meets or exceeds the specifications, while ensuring appropriateness of the approach to the local conditions and the rest of the project operating environment. This methodology must be laid out in an implementation timetable that is within the duration of the contract as specified in the Data Sheet (DS nos. 29 and 30).

Proposers must be fully aware that the products or services that UNDP requires may be transferred, immediately or eventually, by UNDP to the Government partners, or to an entity nominated by the latter, in accordance with UNDP’s policies and procedures. All proposers are therefore required to submit the following in their proposals:

- a) A statement of whether any import or export licences are required in respect of the goods to be purchased or services to be rendered, including any restrictions in the country of origin, use or dual use nature of the goods or services, including any disposition to end users; and
- b) Confirmation that the Proposer has obtained license of this nature in the past, and have an expectation of obtaining all the necessary licenses, should their Proposal be rendered the most responsive.

- 15.3 Management Structure and Key Personnel – This section should include the comprehensive curriculum vitae (CVs) of key personnel that will be assigned to support the implementation of the proposed methodology, clearly defining the roles and responsibilities vis-à-vis the proposed methodology. CVs should establish competence and demonstrate qualifications in areas relevant to the TOR.

In complying with this section, the Proposer assures and confirms to UNDP that the personnel being nominated are available for the Contract on the dates proposed. If any of the key personnel later becomes unavailable, except for unavoidable reasons such as death or medical incapacity, among other possibilities, UNDP reserves the right to consider the proposal non-responsive. Any deliberate substitution arising from unavoidable reasons, including delay in the implementation of the project of programme through no fault of the Proposer shall be made only with UNDP’s acceptance of the justification for substitution, and UNDP’s approval of the qualification of the replacement who shall be either of equal or superior credentials as the one being replaced.

- 15.4 Where the **Data Sheet** requires the submission of the Proposal Security, the Proposal Security shall be included along with the Technical Proposal. The Proposal Security may be forfeited by UNDP, and reject the Proposal, in the event of any or any combination of the following conditions:

- a) If the Proposer withdraws its offer during the period of the Proposal Validity specified in the **Data Sheet** (DS no. 11), or;
- b) If the Proposal Security amount is found to be less than what is required by UNDP as indicated in the **Data Sheet** (DS no. 9), or;
- c) In the case the successful Proposer fails:
 - i. to sign the Contract after UNDP has awarded it;
 - ii. to comply with UNDP's variation of requirement, as per RFP clause 35; or
 - iii. to furnish Performance Security, insurances, or other documents that UNDP may require as a condition to rendering the effectivity of the contract that may be awarded to the Proposer.

16. Financial Proposals

The Financial Proposal shall be prepared using the attached standard form (Section 7). It shall list all major cost components associated with the services, and the detailed breakdown of such costs. All outputs and activities described in the Technical Proposal must be priced separately on a one-to-one correspondence. Any output and activities described in the Technical Proposal but not priced in the Financial Proposal, shall be assumed to be included in the prices of other activities or items, as well as in the final total price.

17. Currencies

All prices shall be quoted in the currency indicated in the **Data Sheet** (DS no. 15). However, where Proposals are quoted in different currencies, for the purposes of comparison of all Proposals:

- a) UNDP will convert the currency quoted in the Proposal into the UNDP preferred currency, in accordance with the prevailing UN operational rate of exchange on the last day of submission of Proposals; and
- b) In the event that the proposal found to be the most responsive to the RFP requirement is quoted in another currency different from the preferred currency as per Data Sheet (DS no. 15), then UNDP shall reserve the right to award the contract in the currency of UNDP's preference, using the conversion method specified above.

Proposals submitted by two (2) or more Proposers shall all be rejected if they are found to have any of the following:

- a) they have at least one controlling partner, director or shareholder in common; or
- b) any one of them receive or have received any direct or indirect subsidy from the other/s; or
- c) they have the same legal representative for purposes of this RFP; or
- d) they have a relationship with each other, directly or through common third parties, that puts them in a position to have access to information about, or influence on the Proposal of, another Proposer regarding this RFP process;
- e) they are subcontractors to each other's Proposal, or a subcontractor to one Proposal also submits another Proposal under its name as lead Proposer; or
- f) an expert proposed to be in the team of one Proposer participates in more than one Proposal received for this RFP process. This condition does not apply to subcontractors being included in more than one Proposal.

18. Documents Establishing the Eligibility and Qualifications of the Proposer

The Proposer shall furnish documentary evidence of its status as an eligible and qualified vendor, using the forms provided under Section 5, Proposer Information Forms. In order to award a

contract to a Proposer, its qualifications must be documented to UNDP's satisfaction. These include, but are not limited to, the following:

- a) That, in the case of a Proposer offering to supply goods under the Contract which the Proposer did not manufacture or otherwise produce, the Proposer has been duly authorized by the goods' manufacturer or producer to supply the goods in the country of final destination;
- b) That the Proposer has the financial, technical, and production capability necessary to perform the Contract; and
- c) That, to the best of the Proposer's knowledge, it is not included in the UN 1267/1989 List or the UN Ineligibility List, nor in any and all of UNDP's list of suspended and removed vendors.

19. Joint Venture, Consortium or Association

If the Proposer is a group of legal entities that will form or have formed a joint venture, consortium or association at the time of the submission of the Proposal, they shall confirm in their Proposal that : (i) they have designated one party to act as a lead entity, duly vested with authority to legally bind the members of the joint venture jointly and severally, and this shall be duly evidenced by a duly notarized Agreement among the legal entities, which shall be submitted along with the Proposal; and (ii) if they are awarded the contract, the contract shall be entered into, by and between UNDP and the designated lead entity, who shall be acting for and on behalf of all the member entities comprising the joint venture.

After the Proposal has been submitted to UNDP, the lead entity identified to represent the joint venture shall not be altered without the prior written consent of UNDP. Furthermore, neither the lead entity nor the member entities of the joint venture can:

- a) Submit another proposal, either in its own capacity; nor
- b) As a lead entity or a member entity for another joint venture submitting another Proposal.

The description of the organization of the joint venture/consortium/association must clearly define the expected role of each of the entity in the joint venture in delivering the requirements of the RFP, both in the Proposal and the Joint Venture Agreement. All entities that comprise the joint venture shall be subject to the eligibility and qualification assessment by UNDP.

Where a joint venture is presenting its track record and experience in a similar undertaking as those required in the RFP, it should present such information in the following manner:

- a) Those that were undertaken together by the joint venture; and
- b) Those that were undertaken by the individual entities of the joint venture expected to be involved in the performance of the services defined in the RFP.

Previous contracts completed by individual experts working privately but who are permanently or were temporarily associated with any of the member firms cannot be claimed as the experience of the joint venture or those of its members, but should only be claimed by the individual experts themselves in their presentation of their individual credentials.

If a joint venture's Proposal is determined by UNDP as the most responsive Proposal that offers the best value for money, UNDP shall award the contract to the joint venture, in the name of its designated lead entity. The lead entity shall sign the contract for and on behalf of all other member entities.

20. Alternative Proposals

Unless otherwise specified in the Data Sheet (DS nos. 5 and 6), alternative proposals shall not be considered. Where the conditions for its acceptance are met, or justifications are clearly established, UNDP reserves the right to award a contract based on an alternative proposal.

21. Validity Period

Proposals shall remain valid for the period specified in the Data Sheet (DS no. 8), commencing on the submission deadline date also indicated in the Data Sheet (DS no. 21). A Proposal valid for a shorter period shall be immediately rejected by UNDP and rendered non-responsive.

In exceptional circumstances, prior to the expiration of the proposal validity period, UNDP may request Proposers to extend the period of validity of their Proposals. The request and the responses shall be made in writing, and shall be considered integral to the Proposal.

22. Proposer's Conference

When appropriate, a proposer's conference will be conducted at the date, time and location specified in the Data Sheet (DS no. 7). All Proposers are encouraged to attend. Non-attendance, however, shall not result in disqualification of an interested Proposer. Minutes of the proposer's conference will be either posted on the UNDP website, or disseminated to the individual firms who have registered or expressed interest with the contract, whether or not they attended the conference. No verbal statement made during the conference shall modify the terms and conditions of the RFP unless such statement is specifically written in the Minutes of the Conference, or issued/posted as an amendment in the form of a Supplemental Information to the RFP.

D. SUBMISSION AND OPENING OF PROPOSALS

23. Submission

23.1 The Financial Proposal and the Technical Proposal Envelopes MUST BE COMPLETELY SEPARATE and each of them must be submitted sealed individually and clearly marked on the outside as either "TECHNICAL PROPOSAL" or "FINANCIAL PROPOSAL", as appropriate. Each envelope MUST clearly indicate the name of the Proposer. The outer envelopes shall bear the address of UNDP as specified in the Data Sheet (DS no.20) and shall include the Proposer's name and address, as well as a warning that state "not to be opened before the time and date for proposal opening" as specified in the Data Sheet (DS no. 24). The Proposer shall assume the responsibility for the misplacement or premature opening of Proposals due to improper sealing and labeling by the Proposer.

23.2 Proposers must submit their Proposals in the manner specified in the Data Sheet (DS nos. 22 and 23). When the Proposals are expected to be in transit for more than 24 hours, the Proposer must ensure that sufficient lead time has been provided in order to comply with UNDP's deadline for submission. UNDP shall indicate for its record that the official date and time of receiving the Proposal is the actual date and time when the said Proposal has physically arrived at the UNDP premises indicated in the Data Sheet (DS no. 20).

23.3 Proposers submitting Proposals by mail or by hand shall enclose the original and each copy of the Proposal, in separate sealed envelopes, duly marking each of the envelopes as "Original Proposal" and "Copy of Proposal" as appropriate. The 2 envelopes shall then be sealed in an outer envelope. The number of copies required shall be as specified in the Data

Sheet (DS No. 19). In the event of any discrepancy between the contents of the “Original Proposal” and the “Copy of Proposal”, the contents of the original shall govern. The original version of the Proposal shall be signed or initialed by the Proposer or person(s) duly authorized to commit the Proposer on every page. The authorization shall be communicated through a document evidencing such authorization issued by the highest official of the firm, or a Power of Attorney, accompanying the Proposal.

- 23.4 Proposers must be aware that the mere act of submission of a Proposal, in and of itself, implies that the Proposer accepts the General Contract Terms and Conditions of UNDP as attached hereto as Section 11.

24. Deadline for Submission of Proposals and Late Proposals

Proposals must be received by UNDP at the address and no later than the date and time specified in the **Data Sheet** (DS nos. 20 and 21).

UNDP shall not consider any Proposal that arrives after the deadline for submission of Proposals. Any Proposal received by UNDP after the deadline for submission of Proposals shall be declared late, rejected, and returned unopened to the Proposer.

25. Withdrawal, Substitution, and Modification of Proposals

25.1 Proposers are expected to have sole responsibility for taking steps to carefully examine in detail the full consistency of its Proposals to the requirements of the RFP, keeping in mind that material deficiencies in providing information requested by UNDP, or lack clarity in the description of services to be provided, may result in the rejection of the Proposal. The Proposer shall assume the responsibility regarding erroneous interpretations or conclusions made by the Proposer in the course of understanding the RFP out of the set of information furnished by UNDP.

25.2 A Proposer may withdraw, substitute or modify its Proposal after it has been submitted by sending a written notice in accordance with Clause 23.1, duly signed by an authorized representative, and shall include a copy of the authorization (or a Power of Attorney). The corresponding substitution or modification of the Proposal must accompany the respective written notice. All notices must be received by UNDP prior to the deadline for submission and submitted in accordance with RFP Clause 23.1 (except that withdrawal notices do not require copies). The respective envelopes shall be clearly marked “WITHDRAWAL,” “SUBSTITUTION,” or “MODIFICATION”.

25.3 Proposals requested to be withdrawn shall be returned unopened to the Proposers.

25.4 No Proposal may be withdrawn, substituted, or modified in the interval between the deadline for submission of Proposals and the expiration of the period of proposal validity specified by the Proposer on the Proposal Submission Form or any extension thereof.

26. Proposal Opening

UNDP will open the Proposals in the presence of an ad-hoc committee formed by UNDP of at least two (2) members. If electronic submission is permitted, any specific electronic proposal opening procedures shall be as specified in the **Data Sheet** (DS no. 23).

The Proposers' names, modifications, withdrawals, the condition of the envelope labels/seals, the number of folders/files and all other such other details as UNDP may consider appropriate, will be announced at the opening. No Proposal shall be rejected at the opening stage, except for late submission, for which the Proposal shall be returned unopened to the Proposer.

27. Confidentiality

Information relating to the examination, evaluation, and comparison of Proposals, and the recommendation of contract award, shall not be disclosed to Proposers or any other persons not officially concerned with such process, even after publication of the contract award.

Any effort by a Proposer to influence UNDP in the examination, evaluation and comparison of the Proposals or contract award decisions may, at UNDP's decision, result in the rejection of its Proposal.

In the event that a Proposer is unsuccessful, the Proposer may seek a meeting with UNDP for a debriefing. The purpose of the debriefing is discussing the strengths and weaknesses of the Proposer's submission, in order to assist the Proposer in improving the proposals presented to UNDP. The content of other proposals and how they compare to the Proposer's submission shall not be discussed.

E. EVALUATION OF PROPOSALS

28. Preliminary Examination of Proposals

UNDP shall examine the Proposals to determine whether they are complete with respect to minimum documentary requirements, whether the documents have been properly signed, whether or not the Proposer is in the UN Security Council 1267/1989 Committee's list of terrorists and terrorist financiers, and in UNDP's list of suspended and removed vendors, and whether the Proposals are generally in order, among other indicators that may be used at this stage. UNDP may reject any Proposal at this stage.

29. Evaluation of Proposals

- 29.1 UNDP shall examine the Proposal to confirm that all terms and conditions under the UNDP General Terms and Conditions and Special Conditions have been accepted by the Proposer without any deviation or reservation.
- 29.2 The evaluation team shall review and evaluate the Technical Proposals on the basis of their responsiveness to the Terms of Reference and other documentation provided, applying the evaluation criteria, sub-criteria, and point system specified in the **Data Sheet** (DS no. 32). Each responsive Proposal will be given a technical score. A Proposal shall be rendered non-responsive at this stage if it does not substantially respond to the RFP particularly the demands of the Terms of Reference, which also means that it fails to achieve the minimum technical score indicated in the **Data Sheet** (DS no. 25). Absolutely no changes may be made by UNDP in the criteria, sub-criteria and point system indicated in the **Data Sheet** (DS no. 32) after all Proposals have been received.
- 29.3 In the second stage, only the Financial Proposals of those Proposers who achieve the minimum technical score will be opened for evaluation for comparison and review. The

Financial Proposal Envelopes corresponding to Proposals that did not meet the minimum passing technical score shall be returned to the Proposer unopened. The overall evaluation score will be based either on a combination of the technical score and the financial offer, or the lowest evaluated financial proposal of the technically qualified Proposers. The evaluation method that applies for this RFP shall be as indicated in the **Data Sheet** (DS No. 25).

When the Data Sheet specifies a combined scoring method, the formula for the rating of the Proposals will be as follows:

| |
|--|
| <p><u>Rating the Technical Proposal (TP):</u></p> <p>TP Rating = (Total Score Obtained by the Offer / Max. Obtainable Score for TP) x 100</p> <p><u>Rating the Financial Proposal (FP):</u></p> <p>FP Rating = (Lowest Priced Offer / Price of the Offer Being Reviewed) x 100</p> <p><u>Total Combined Score:</u></p> <p>(TP Rating) x (Weight of TP, e.g. 70%) + (FP Rating) x (Weight of FP, e.g. 30%)</p> <hr/> <p>Total Combined and Final Rating of the Proposal</p> |
|--|

29.4 UNDP reserves the right to undertake a post-qualification exercise aimed at determining, to its satisfaction the validity of the information provided by the Proposer. Such post-qualification shall be fully documented and, among those that may be listed in the Data Sheet (DS No.33), may include, but need not be limited to, all or any combination of the following:

- a) Verification of accuracy, correctness and authenticity of information provided by the Proposer on the legal, technical and financial documents submitted;
- b) Validation of extent of compliance to the RFP requirements and evaluation criteria based on what has so far been found by the evaluation team;
- c) Inquiry and reference checking with Government entities with jurisdiction on the Proposer, or any other entity that may have done business with the Proposer;
- d) Inquiry and reference checking with other previous clients on the quality of performance on ongoing or previous contracts completed;
- e) Physical inspection of the Proposer’s offices, branches or other places where business transpires, with or without notice to the Proposer;
- f) Quality assessment of ongoing and completed outputs, works and activities similar to the requirements of UNDP, where available; and
- g) Other means that UNDP may deem appropriate, at any stage within the selection process, prior to awarding the contract.

30. Clarification of Proposals

To assist in the examination, evaluation and comparison of Proposals, UNDP may, at its discretion, ask any Proposer for a clarification of its Proposal.

UNDP's request for clarification and the response shall be in writing. Notwithstanding the written communication, no change in the prices or substance of the Proposal shall be sought, offered, or permitted, except to provide clarification, and confirm the correction of any arithmetic errors discovered by UNDP in the evaluation of the Proposals, in accordance with RFP Clause 32.

Any unsolicited clarification submitted by a Proposer in respect to its Proposal, which is not a response to a request by UNDP, shall not be considered during the review and evaluation of the Proposals.

31. Responsiveness of Proposal

UNDP's determination of a Proposal's responsiveness will be based on the contents of the Proposal itself.

A substantially responsive Proposal is one that conforms to all the terms, conditions, TOR and other requirements of the RFP without material deviation, reservation, or omission.

If a Proposal is not substantially responsive, it shall be rejected by UNDP and may not subsequently be made responsive by the Proposer by correction of the material deviation, reservation, or omission.

32. Nonconformities, Reparable Errors and Omissions

Provided that a Proposal is substantially responsive, UNDP may waive any non-conformities or omissions in the Proposal that, in the opinion of UNDP, do not constitute a material deviation.

Provided that a Proposal is substantially responsive, UNDP may request the Proposer to submit the necessary information or documentation, within a reasonable period of time, to rectify nonmaterial nonconformities or omissions in the Proposal related to documentation requirements. Such omission shall not be related to any aspect of the price of the Proposal. Failure of the Proposer to comply with the request may result in the rejection of its Proposal.

Provided that the Proposal is substantially responsive, UNDP shall correct arithmetical errors as follows:

- a) if there is a discrepancy between the unit price and the line item total that is obtained by multiplying the unit price by the quantity, the unit price shall prevail and the line item total shall be corrected, unless in the opinion of UNDP there is an obvious misplacement of the decimal point in the unit price, in which case the line item total as quoted shall govern and the unit price shall be corrected;
- b) if there is an error in a total corresponding to the addition or subtraction of subtotals, the subtotals shall prevail and the total shall be corrected; and
- c) if there is a discrepancy between words and figures, the amount in words shall prevail, unless the amount expressed in words is related to an arithmetic error, in which case the amount in figures shall prevail subject to the above.

If the Proposer does not accept the correction of errors made by UNDP, its Proposal shall be rejected.

F. AWARD OF CONTRACT

33. Right to Accept, Reject, or Render Non-Responsive Any or All Proposals

UNDP reserves the right to accept or reject any Proposal, to render any or all of the Proposals as non-responsive, and to reject all Proposals at any time prior to award of contract, without incurring any liability, or obligation to inform the affected Proposer(s) of the grounds for UNDP's action. Furthermore, UNDP shall not be obliged to award the contract to the lowest price offer.

UNDP shall also verify, and immediately reject their respective Proposal, if the Proposers are found to appear in the UN's Consolidated List of Individuals and Entities with Association to Terrorist Organizations, in the List of Vendors Suspended or Removed from the UN Secretariat Procurement Division Vendor Roster, the UN Ineligibility List, and other such lists that as may be established or recognized by UNDP policy on Vendor Sanctions. (See <http://www.undp.org/content/undp/en/home/operations/procurement/protestandsanctions/> for details)

34. Award Criteria

Prior to expiration of the period of proposal validity, UNDP shall award the contract to the qualified Proposer with the highest total score based on the evaluation method indicated in the **Data Sheet** (DS nos. 25 and 32).

35. Right to Vary Requirements at the Time of Award

At the time of award of Contract, UNDP reserves the right to vary the quantity of services and/or goods, by up to a maximum twenty-five per cent (25%) of the total offer, without any change in the unit price or other terms and conditions.

36. Contract Signature

Within fifteen (15) days from the date of receipt of the Contract, the successful Proposer shall sign and date the Contract and return it to UNDP.

Failure of the successful Proposer to comply with the requirement of RFP Clause 35 and this provision shall constitute sufficient grounds for the annulment of the award, and forfeiture of the Proposal Security if any, and on which event, UNDP may award the Contract to the Proposer with the second highest rated Proposal, or call for new Proposals.

37. Performance Security

A performance security, if required, shall be provided in the amount and form provided in Section 9 and by the deadline indicated in the **Data Sheet** (DS no. 14), as applicable. Where a Performance Security will be required, the submission of the said document, and the confirmation of its acceptance by UNDP, shall be a condition for the effectivity of the Contract that will be signed by and between the successful Proposer and UNDP.

38. Bank Guarantee for Advanced Payment

Except when the interests of UNDP so require, it is the UNDP's preference to make no advanced payment(s) on contracts (i.e., payments without having received any outputs). In the event that the Proposer requires an advanced payment upon contract signature, and if such request is duly accepted by UNDP, and the said advanced payment exceeds 20% of the total proposal price, or exceed the amount of USD 30,000, UNDP shall require the Proposer to submit a Bank Guarantee in the same amount as the advanced payment. A bank guarantee for advanced payment shall be furnished in the form provided in Section 10.

39. Vendor Protest

UNDP's vendor protest procedure provides an opportunity for appeal to those persons or firms not awarded a purchase order or contract through a competitive procurement process. In the event that a Proposer believes that it was not treated fairly, the following link provides further details regarding UNDP vendor protest procedures:

<http://www.undp.org/content/undp/en/home/operations/procurement/protestandsanctions/>

Instructions to Proposers

DATA SHEET

The following data for the services to be procured shall complement, supplement, or amend the provisions in the Instruction to Proposers. In the case of a conflict between the Instructions to Proposers, the Data Sheet, and other annexes or references attached to the Data Sheet, the provisions in the Data Sheet shall govern.

| DS No. ² | Cross Ref. to Instructions | Data | Specific Instructions / Requirements |
|---------------------|----------------------------|---|--|
| 1 | | Project Title: | PARLIAMENT FM RADIO STATION (Rule of law and Constitutional Democracy Programme) |
| 2 | | Title of Services/Work: | SUPPLY AND INSTALLATION OF SOUND TREATMENT, ACOUSTICS MATERIALS AND STUDIO ELECTRICAL INSTALLATIONS |
| 3 | | Country / Region of Work Location: | Uganda – Parliament House, Parliamentary Avenue, Kampala. |
| 4 | C.13 | Language of the Proposal: | <input checked="" type="checkbox"/> English <input type="checkbox"/> French <input type="checkbox"/> Spanish |
| 5 | C.20 | Conditions for Submitting Proposals for Parts or sub-parts of the TOR | <input checked="" type="checkbox"/> Not allowed |
| 6 | C.20 | Conditions for Submitting Alternative Proposals | <input checked="" type="checkbox"/> Shall not be considered <input type="checkbox"/> Shall be considered. A proposer may submit an alternative proposal [only one], but only if it also submits a proposal that meets the base case (requirements defined in the Section 3 (ToR) of RFP). UNDP shall only consider the alternative proposals offered by the Proposer whose proposal for the base case was determined to be the proposal with the highest evaluated score. |

² All DS number entries in the Data Sheet are cited as reference in the Instructions to Proposers. All DS nos. corresponding to a Data must not be modified. Only information on the 3rd column may be modified by the user. If the information does not apply, the 3rd column must state “N/A” but must not be deleted.

| | | | |
|----|--------------------|---|--|
| 7 | C.22 | Yes pre-proposal conference will be held. | Pre-proposal conference will be held on 11 th December 2017 at 11 am at Parliamentary Buildings, Plot 16-18, Parliament Avenue, Kampala |
| 8 | C.21 | Period of Proposal Validity commencing on the submission date | <input type="checkbox"/> 60 days <input type="checkbox"/> 90 days <input checked="" type="checkbox"/> 120 days |
| 9 | B.9.5 C.15.4 b) | Bid security | <input type="checkbox"/> Required <input checked="" type="checkbox"/> Not Required |
| 10 | B.9.5 | Acceptable forms of Proposal Security ³ | <input type="checkbox"/> Bank Guarantee |
| 11 | B.9.5 C.15.4 a) | Validity of bid Security | <input type="checkbox"/> 120 days |
| 12 | | Advanced Payment upon signing of contract | <input checked="" type="checkbox"/> Not allowed |
| 13 | | Liquidated Damages | <input checked="" type="checkbox"/> Will be imposed under the following conditions: Percentage of contract price per day of delay: 0.10% (no fees will be charged for the first seven days of delay) Max. no. of days of delay: 45 After which UNDP may terminate the contract. |
| 14 | F.37 | Performance Security | <input type="checkbox"/> Required <input checked="" type="checkbox"/> Not required |
| 15 | C.17, C.17 b) | Preferred Currency of Proposal and Method for Currency conversion | <input checked="" type="checkbox"/> United States Dollars (US\$) for off shore vendors <input checked="" type="checkbox"/> Uganda shillings (UGX) for local vendors- UN prevailing rate at the time of evaluation will apply for comparison purposes |

³ Surety bonds or other instruments issued by non-bank Financial Institutions are least preferred by UNDP. Unless stated otherwise, they shall be considered unacceptable to UNDP.

| | | | |
|----|--------------------------|---|---|
| | | | |
| 16 | B.10.1 | Deadline for submitting requests for clarifications/questions | 7 days before the submission date. |
| 17 | B.10.1 | Contact Details for submitting clarifications/questions ⁴ | Focal Person in UNDP: Winifred Senaji Address: Plot No. 11 Yusuf Lule Road, Kampala, Uganda E-mail address dedicated for this purpose: winifred.senaji@undp.org |
| 18 | B.11.1 | Manner of Disseminating Supplemental Information to the RFP and responses/clarifications to queries | <input checked="" type="checkbox"/> Direct communication to prospective Proposers by email and Posting on the UNDP procurement notices. |
| 19 | D.23.3 | No. of copies of Proposal that must be submitted [if transmitted by courier] | Original: 1 (One) Copies: 1(One) For email submission, just one copy of the signed scanned proposal should be submitted as attachment. Please follow section 23 below for details on email submission. |
| 20 | D.23.1 D.23.2 D.24 | Proposal Submission Address | United Nations Development Programme Plot No. 11 Yusuf Lule Road, Kampala, Uganda |
| 21 | C.21 D.24 | Deadline of Submission | Date and Time: December 18, 2017 11:00 AM |
| 22 | D.23.2 | Allowable Manner of Submitting Proposals | <input checked="" type="checkbox"/> Courier/Hand Delivery- Financial and technical proposals must submitted in two separate and sealed envelopes clearly marked 'Financial proposal' and 'Technical proposal'. Vendor name must be clearly indicated on the envelopes <input checked="" type="checkbox"/> Electronic submission of Bid ⁵ (8 MB maximum per email transmission) |

⁴ This contact person and address is officially designated by UNDP. If inquiries are sent to other person/s or address/es, even if they are UNDP staff, UNDP shall have no obligation to respond nor can UNDP confirm that the query was officially received.

⁵ If this will be allowed, security features (e.g., encryption, authentication, digital signatures, etc.) are strictly required and must

| | | | |
|----|----------------|---|---|
| 23 | D.23.2 D.26 | Conditions and Procedures for electronic submission and opening, if allowed | <p> <input checked="" type="checkbox"/> Official Address for e-submission: TENDERS.KAMPALA@UNDP.ORG </p> <p> <input checked="" type="checkbox"/> Free from virus and corrupted files </p> <p> <input checked="" type="checkbox"/> Format: PDF files only, password protected </p> <p> <input checked="" type="checkbox"/> Password <u>must</u> not be provided unless requested by UNDP </p> <p> <input checked="" type="checkbox"/> Max. File Size per transmission: 8 MB </p> <p> <input checked="" type="checkbox"/> Max. No. of transmission: Unlimited </p> <p> <input checked="" type="checkbox"/> No. of copies to be transmitted: 1 </p> <p> <input checked="" type="checkbox"/> Mandatory subject of email: <i>See below instructions for details</i> </p> <p> <input checked="" type="checkbox"/> Virus Scanning Software to be Used prior to transmission: Symantec/Norton/ESET NOD 32/AVG/Avira/Bitdefender/Kaspersky/F-secure/G Data/Bull Guard/Avast </p> <p> <input checked="" type="checkbox"/> Time Zone to be Recognized: East Africa Time Zone (UTC+3) </p> <p> <input checked="" type="checkbox"/> Other conditions: <i>See below further instructions for electronic submissions</i> </p> <p>Further Instruction for electronic submission</p> <p>The Proposer may choose to submit their proposals by e-mail to TENDERS.KAMPALA@UNDP.ORG In this case the Proposer shall send separate proposals for: 1) technical proposal; 2) financial proposal as separate attachments to the message(s).</p> <p>Having prepared the Proposal in paper formats as specified in Sections 4, 5, and 6 the entire Technical Proposal should be scanned or otherwise converted into one or more electronic PDF (Adobe Acrobat) format files and attached to one or more E-mails. Same should be done for Section 7 – Financial Proposal.</p> <p>Important: Proposers should submit Technical proposal and Financial proposal in separate emails with the below mandatory subject lines:</p> |
|----|----------------|---|---|

be enforced to ensure confidentiality and integrity of contents.

| | | | |
|----|--------|---|---|
| | | | <p>“Technical proposal - SUPPLY AND INSTALLATION OF SOUND TREATMENT, ACOUSTICS MATERIALS AND STUDIO ELECTRICAL INSTALLATIONS</p> <p>and in a separate email:</p> <p>“Financial proposal - SUPPLY AND INSTALLATION OF SOUND TREATMENT, ACOUSTICS MATERIALS AND STUDIO ELECTRICAL INSTALLATIONS, DO NOT OPEN”</p> <p>To secure both your technical and financial offer please SET-UP A PASSWORD for both Proposals. The password for Financial Proposal will be requested from the Proposers if they are successful in the Technical Proposal evaluation. Only those who achieved the minimum score on the technical evaluation will be requested to provide the password to the financial proposals.</p> <p>It is strongly suggested that Proposers make a note of the passwords and keep them in a safe place. If we are unable to open the file because of forgotten password(s) the proposal will be disqualified.</p> <p>Proposers may send as many e-mails as needed; however, the size of each e-mail should not exceed eight megabytes (8 MB). As an e-mail can take some time to arrive after it is sent, we advise all Proposers to send e-mail submissions well before the deadline. Please be aware that bids e-mailed to UNDP will be rejected if they are received after the deadline for bid submission.</p> <p>When choosing to submit their proposals electronically, Proposers are solely responsible for ensuring that any and all files sent to UNDP are readable, that is, uncorrupted, in the indicated electronic format, and free from viruses and malware. Failure to provide readable files will result in the proposal being rejected.</p> |
| 24 | D.23.1 | Date, time and venue for opening of Proposals | Public opening will not be conducted |

| | | | |
|----|--------------------------|--|--|
| 25 | E.29.2 E.29.3 F.34 | Evaluation method to be used in selecting the most responsive Proposal | <input checked="" type="checkbox"/> Combined Scoring Method, using the 70%-30% distribution for technical and financial proposals, respectively, where the minimum passing score of technical proposal is 70% |
| 26 | C.15.1 | Required Documents that must be Submitted to Establish Qualification of Proposers (In “Certified True Copy” form only) | <input checked="" type="checkbox"/> Company Profile, which should <u>not</u> exceed fifteen (15) pages, including printed brochures and product catalogues relevant to the goods/services being procured <input checked="" type="checkbox"/> Official Letter of Appointment as local representative, if Bidder is submitting a Bid in behalf of an entity located outside the focus country of the study <input checked="" type="checkbox"/> Quality Certificate (e.g., ISO, etc.) and/or other similar certificates, accreditations, awards and citations received by the Bidder, if any <input checked="" type="checkbox"/> Latest Audited Financial Statement (Income Statement and Balance Sheet) including Auditor’s Report for the past two 2 years <input checked="" type="checkbox"/> Proposers MUST submit one CV for each team member. Do not submit more than one CV per team member. Note: Proposers are to ensure that CVs submitted are relevant to the ToRs and meet qualification criteria in the RFP. <input checked="" type="checkbox"/> All information regarding any past and current litigation during the last three (3) years, in which the bidder is involved, indicating the parties concerned, the subject of the litigation, the amounts involved, and the final resolution if already concluded. |
| 27 | | Other documents that may be Submitted to Establish Eligibility | Where applicable |
| 28 | C.15.2 | Latest Expected date for commencement of Contract | <i>December 30, 2017</i> |
| 29 | C.15.2 | Expected duration of contract (Target Commencement Date and Completion Date) | 6 weeks |

| | | | |
|----|-----|--------------------------------------|--|
| 31 | | UNDP will award the contract to: | <input checked="" type="checkbox"/> One Proposer only |
| | E28 | Preliminary Examination of Proposals | <p>Proposals would be rejected at the submission stage or found to be technically noncompliant due to errors in presentation and failure to follow bidding instructions.</p> <p>Below are some of the more common examples of why proposals are rejected by UNDP at the submission stage. Proposers are urged to read this before submission and to check that their proposal conforms to each of these points and the instructions as noted in the bidding documents.</p> <ul style="list-style-type: none"> • Proposal is submitted after the deadline for submission, either by hand or electronically. Emailed proposals sent just before the deadline may arrive after the deadline and be rejected. Therefore, make sure to submit your proposals beforehand. • Proposal not submitted to correct physical or electronic address. Note that the address for proposal submission is different to the address for bid questions. • Proposal is submitted as a single package, without separating technical and financial proposal. • Proposal is not signed as per the instructions in the RFP. • Not all sufficient documents have been provided. • Documents provided are not in English. • Documents provided do not directly address each point of the evaluation criteria. • Proposal is more like a brochure for the firm without specifically addressing the specific evaluation criteria of the RFP and TOR. • Proposal does not offer goods or services which have been specifically requested by UNDP in the Terms of Reference. • Failure to enclose the Proposal Submission Form (see Section 4). • The Proposer failed to consult the UNDP website before the deadline for bid submission and did not see the changes to the RFP/TOR listed there which need to be incorporated in the proposal. |

| | | | |
|----|----------------|--|--|
| | | | <ul style="list-style-type: none"> • The Proposer failed to read the minutes of the Proposers conference and to include the relevant points in their proposal. • The Proposer declines or proposes a major deviation to UNDP General Conditions of Contract (see Section 8). • Proposal contains viruses and/or corrupted files. The Proposers should ensure that submitted proposals DO NOT contain viruses and/or corrupted files. Such proposals will be rejected. |
| 32 | E.29.2 F.34 | Criteria for the Award of Contract and Evaluation of Proposals | <input checked="" type="checkbox"/> See Section 2 Instruction to Proposers Articles E and F, DS 31 above, and award criteria below “Technical Proposal Evaluation Forms (See Tables below) |
| 33 | E.29.4 | Post-Qualification Actions | <input checked="" type="checkbox"/> Verification of accuracy, correctness and authenticity of the information provided by the bidder on the legal, technical and financial documents submitted; |
| 34 | | Conditions for Determining Contract Effectivity | <input checked="" type="checkbox"/> Others Upon signing of the contract by both parties |
| 35 | | Other Information Related to the RFP | N/A |

| Summary of Technical Proposal Evaluation Forms | | Score Weight | Points Obtainable |
|--|--|--------------|-------------------|
| 1. | Expertise of Firm / Organization | 30% | 300 |
| 2. | Proposed Methodology, Approach and Implementation Plan | 40% | 400 |
| 3. | Management Structure and Key Personnel | 30% | 300 |
| Total | | | 1000 |

| Technical Proposal Evaluation Form 1 | | Points obtainable |
|---|---|----------------------|
| Organizational Capability of the Firm/Organization | | |
| 1.1 | Reputation of Organization and Staff / Credibility / Reliability / Industry Standing | 50 |
| 1.2 | General Organizational Capability which is likely to affect implementation <ul style="list-style-type: none"> - Officially registered legal entity – 20 pts. - Financial stability – 30 pts. - Age of the firm – 15 years: 20 pts. Each additional year is 5 point, up to maximum 40 pts. | 90 |
| 1.3 | Extent to which any work would be subcontracted (subcontracting carries additional risks which may affect project implementation, but properly done it offers a chance to access specialised skills.) | 20 |
| 1.4 | Quality assurance procedures | 25 |
| 1.5 | Relevance: <ul style="list-style-type: none"> - Officially registered legal entity; - Minimum 15 years of experience in carpentry works - Minimum 10 studios constructed by bidding entity - At least three (3) years' experience of work in Africa. - Must possess optimal knowledge on sound acoustics treatment i.e. suitable materials to manage sound. - Must possess knowledge of earthing and electrical installations. - Should have been involved in at least two (2) similar projects of construction of broadcast studios in the past five (5) years. - Must possess knowledge in radio studio operations and workflows. - Background in studio lighting design and implementation; | 115 |
| | | 300 |

| Technical Proposal Evaluation Form 2 | | Points Obtainable |
|---|--|----------------------|
| Proposed Methodology, Approach and Implementation Plan | | |
| 2.1 | To what degree does the Proposer understand the task? | 25 |
| 2.2 | Have the objectives of the assignment explained in Section D of the Scope of Work been addressed in sufficient detail? | 30 |
| 2.3 | Are the different components of the project adequately weighted relative to one another? | 20 |
| 2.4 | Does the proposed methodology clearly explain how each deliverable will be delivered? | 55 |
| 2.5 | Is the conceptual framework adopted appropriate for the task? | 65 |

| | | |
|-----|--|-----|
| 2.6 | Is the scope of task well defined and does it correspond to the TOR? | 120 |
| 2.7 | Is the presentation clear and is the sequence of activities and the planning logical, realistic and promise efficient implementation to the project? | 85 |
| | | 400 |

| Technical Proposal Evaluation Form 3 | | | | Points Obtainable |
|---|--|----|-----------|----------------------|
| Management Structure and Key Personnel | | | | |
| 3.1 | Task Manager – General qualification/suitability for the project | | Sub-Score | 140 |
| | The Task manager should be a Master Craftsman- Carpentry with an advanced certificate in carpentry and joinery | 50 | | |
| | Experience of 15 years in carpentry and joinery | 50 | | |
| | Must have been involved in at least 10 studio construction projects | 20 | | |
| | Excellent writing and communication skills in English | 20 | | |
| | | | 140 | |
| 3.2 | Team of Experts - General qualification/suitability for the project | | | 160 |
| | Electrical Technician <ul style="list-style-type: none"> Higher Diploma in electrical/electronics engineering from a recognized institution Must have electrical installation permit Class C Must have been involved in at least 5 studio electrical installations | 50 | | |
| | IT Technician <ul style="list-style-type: none"> Higher Diploma in ICT or related field from a recognized institution Must have been involved in at least 5 studio networking and installation projects of similar nature | 50 | | |

| | | | | |
|--|---|----|-----|-----|
| | Master Technician – Masonry <ul style="list-style-type: none"> • Certificate in masonry or building construction works or related field • At least 5 years of experience | 30 | | |
| | Language Proficiency for all experts | | | |
| | Excellent writing and communication skills in English | 15 | | |
| | Fluency in other local languages of Uganda. | 15 | | |
| | | | 160 | |
| | Total Part 3 | | | 300 |

Section 3: Scope of Work (SOW)⁶

SUPPLY AND INSTALLATION OF SOUND TREATMENT, ACOUSTICS MATERIALS AND STUDIO ELECTRICAL INSTALLATIONS

1. INTRODUCTION:

Parliament of Uganda, through its five-year strategic investment plan for the period 2012-2017, defined strategies for strengthening the role of Parliament in delivering on its mandate. Strategy 3 focused on increasing public involvement and participation in Parliamentary business – legislation and executive oversight. This was envisaged to be achieved through: i) Developing citizens' capacity to play informed roles and expand their political engagement ii) Strengthening public information service iii) Institutionalizing Parliamentary Outreach programmes; iv) Supporting committee-based site visits and public hearings; iv) Developing feedback mechanisms between Parliament and the public.

In order for the Parliament to interface actively with the public, it was considered necessary to establish a modern communications platform. Parliament FM Radio was identified as a possible tool that could contribute to: i) Bringing Parliament closer to the people; ii) Transparency and accountability for decisions made on behalf of the Ugandan citizens; iii) Better representation – as citizens would be able to judge the quality of debates/submissions etc.

In addition, the Inter-parliamentary Union (IPU) recommended that Member countries, Uganda inclusive, should establish TV and Radio broadcasting services to encourage Parliament-Public contact. Following from this lead, Uganda is progressing in the footsteps of countries in Africa and beyond that have established either TV, FM radio or both broadcasting services. These countries include: Zambia, Rwanda, Benin, Gambia, Scotland, Canada, United Kingdom etc.

In the period 2014-2015, Parliament undertook feasibility studies (i.e. socio-political and technical) to inform the process of setting up the broadcasting services. These studies appraised the proposed FM radio station recommending that Parliament establish the services as intended.

In June 2017, Parliament further engaged a team of broadcast consultants to support its technical team with frequency applications, develop studio architectural designs and systems integration layout, provide radio equipment specifications and supervise implementation of sound treatment.

It is against the above background, that Parliament of Uganda, through funding from United Nations Development Programme (UNDP), would like to engage a Consultant to design and supervise the implementation of broadcast studio set-up in selected locations within its precincts.

2. SCOPE OF WORK:

Sound treatment works shall include supply and installation of foundation and final acoustics and soundproofing materials for the radio studios and committee rooms located at Parliament House in Kampala. The works shall also include supply of studio furniture like tables and chairs and studio electrical installations like lighting, switches, power sockets and safety resources. The items are further described under “**Soundproofing Materials and Installation Schedule**” section on *page 10*.

All materials and installations supplied must have a minimum of one year warranty with support and maintenance by supplier or their agent. The soundproof doors must have a 3-year warranty.

Supplies shall be delivered and installed under supervision of the Parliamentary Technical Committee and possibly a representative from UNDP.

Below is an impression of final works from main studio.

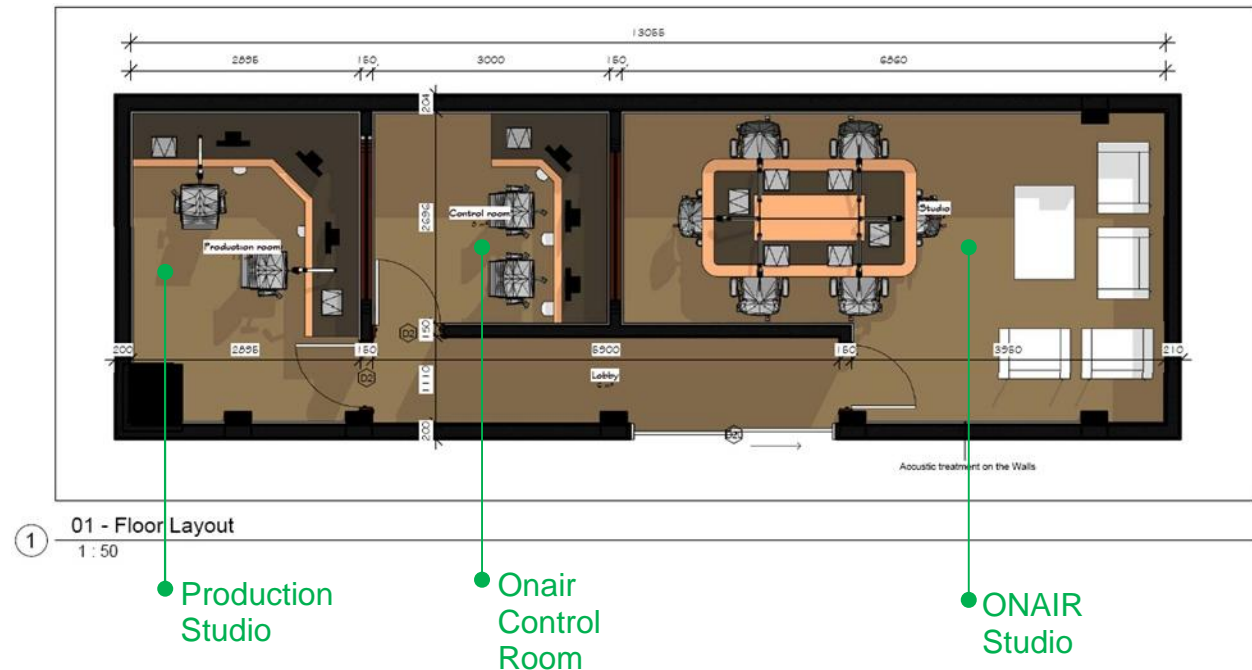

The contractor shall supply and install all soundproofing materials, studio furnishings, safety resources and electrical accessories excluding broadcast equipment. The only work that will remain pending after the soundproofing contractor leaves the site is only that which is related to broadcast and transmission.

3. STUDIOS:

The radio studios space will comprise three units as illustrated below:

- Executive Onair Studio: where show host and guests sit.
- Onair Control Room: where program producer and telephone controller sit.
- Production studio (which also acts as a backup onair studio): where commercial producer sits. This studio is mainly for editing, arranging and basic mastering of audio.

Below are dimensions of the studio area:

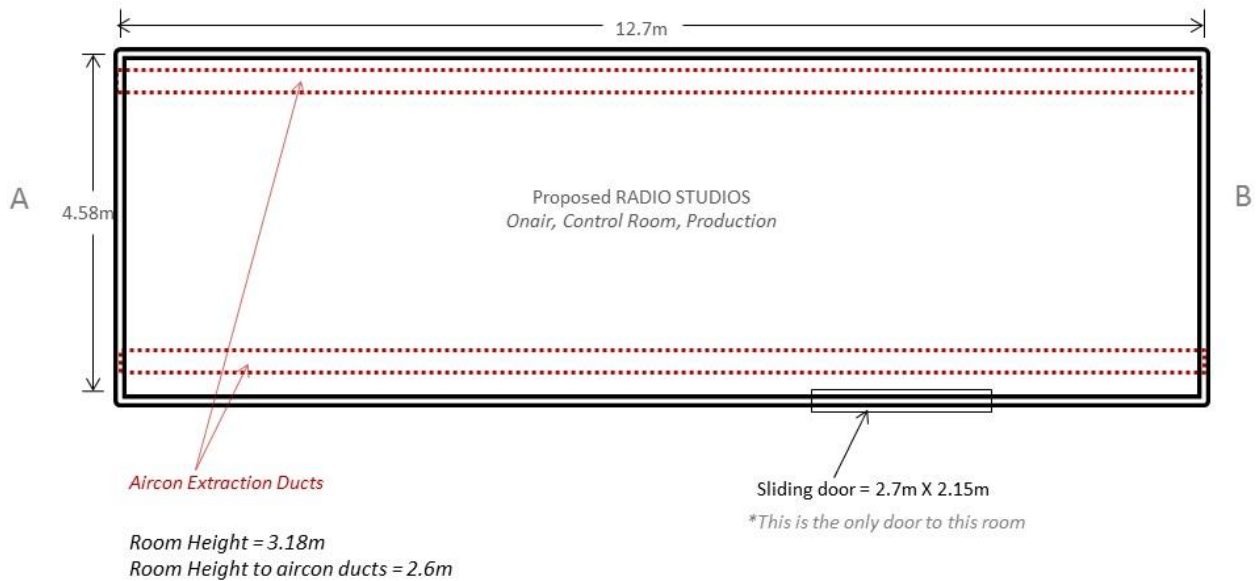

The area where the three studios will be constructed measures 12.7meters by 4.58m with ceiling height at 3.18metres.

There are two extraction ducts running across the room on opposite ends (from side A to B). They are not moveable and must be integrated into studio design or removed. Removal is preferred as they create noise that will disrupt onair sessions in studio.

The contractor will partition this room into three studios with concrete walls to effectively block sound. A ceiling should also be installed into the studio space allowing a sound lock between current ceiling and new one.

The space above shall be converted to facility below:

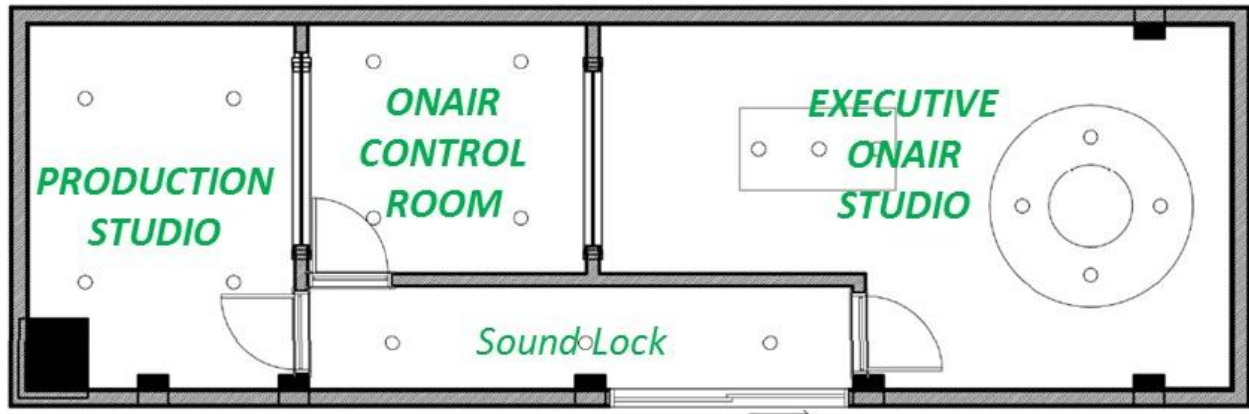

Executive Onair studio will contain minimal equipment, like microphones, monitor speakers, a computer with internet access and operator telephone hybrid. All the other controls will be located in the Onair Control room that will be separated by a double-glazed glass window.

All onair equipment will converge and be controlled from the Onair Control room. Two people will sit in this room all the time, during a typical show – the program producer and telephone assistant. The show presenter will sit in the Onair studio but not control any complex equipment.

4. WALLS AND CEILING TREATMENT:

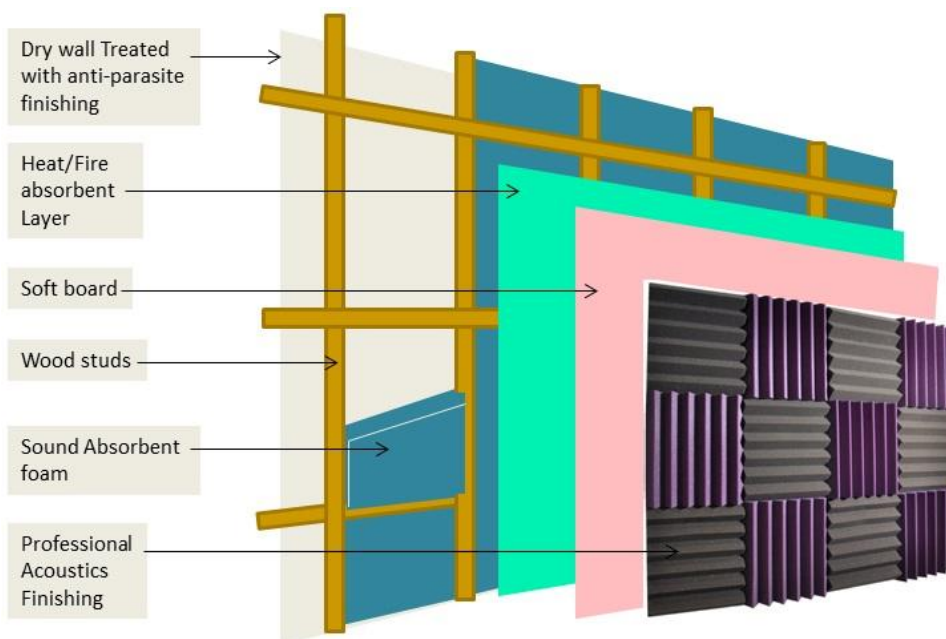

Above are the foundational and finishing works for studio soundproofing. The contractor shall include Carpets and ceiling sound treatment in final proposal. The studios should be able to absorb at least 60dB of sound.

5. DOORS:

The contractor will be allowed to take final measurements of doors sizes under supervision of Project Manager; however, anticipated size is 3'x7'x1-3/4. Each door will have a door closer, handles, hinges and double-glazed glass panel and of the specifications below:

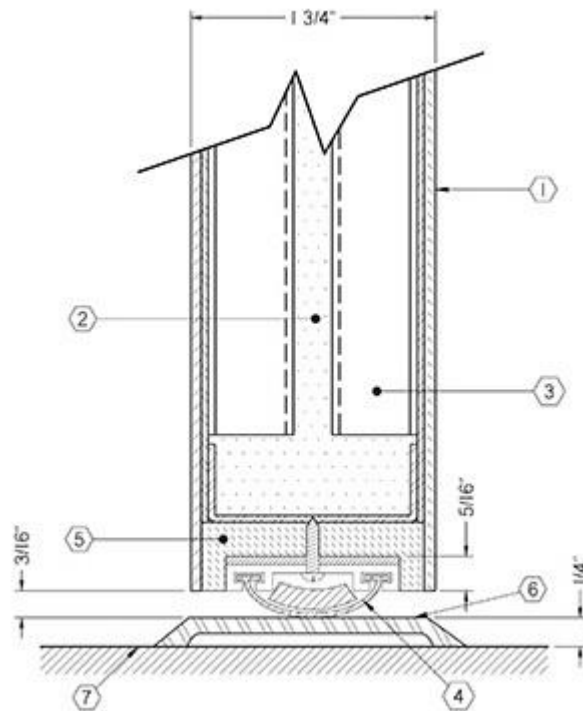

1. Wood face veneer (push side)
2. Acoustic Core
3. Vertical stiffeners
4. Door sweep seal assembly
5. All edges to be solid hardwood, including matching edges at stiles
6. 1/4" high flat acoustic threshold
7. Finished floor

The doors should be of a Sound Transmission Class 33-46 i.e be able to absorb at least 40dB sound pressure level. This means that loud speech can only be heard as a murmur and one must strain to hear loud speech. Each door will have a small double-glazed viewing window.

Each door should have a 3 year service warranty.

6. DOUBLE-GLAZED WINDOWS:

The contractor shall supply and install soundproof double-glazed windows of structure below. The glasses should be angled and have capacity to reflect up to 80dB of sound pressure.

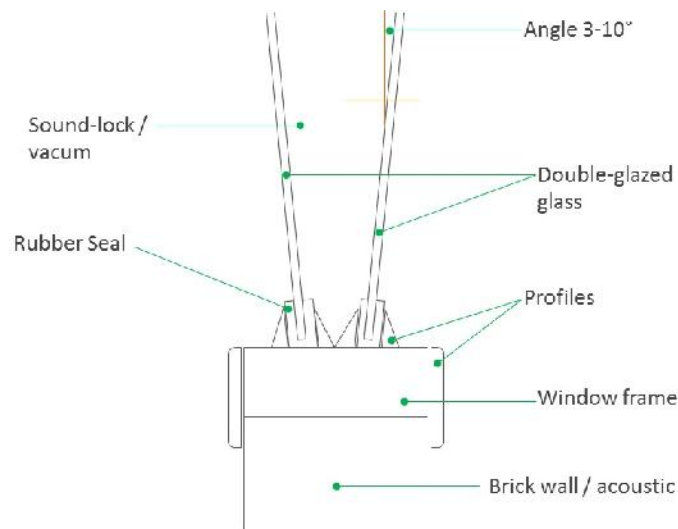

7. LIGHTING

The lights will be 2x1200mm LED Fluorescent Lighting Fitting with a non-corrosive glass cover and associated accessories. Each of these will have 6A Gang 1 way switch. There will also be an LED strip as part ceiling design.

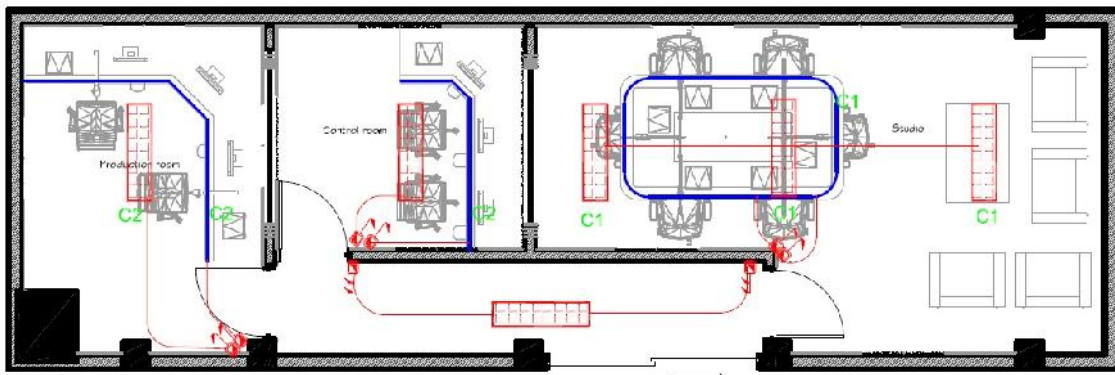

| SYMBOL | DESCRIPTION |
|--------|--|
| | 2 X 1200mm LED Fluorescent Lighting Fitting c/w A non Corrosive Glass Cover and Associated accessories |
| | 6A 2 Gang 1 Way Switch |
| | 6A 1 Gang 1 Way Switch |
| | 6A 1 Gang 2 Way Switch |
| | LED Strip light |

8. POWER:

The contractor will supply and install a consumer board, power and network cabling, trunking, power and network sockets and all related accessories to deliver power to required points in illustration below:

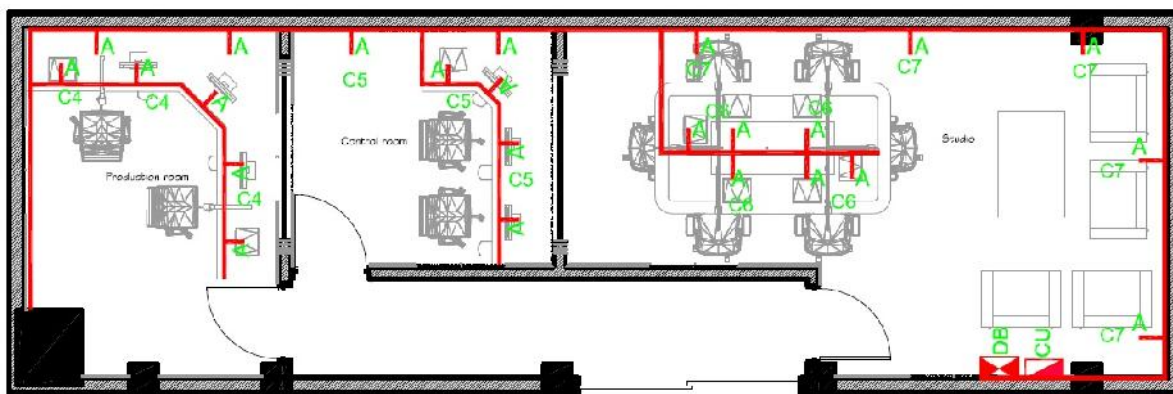

| SYMBOL | DESCRIPTION |
|--------|-----------------------------------|
| | 13A Double Switched Socket Outlet |
| | Television Outlet |
| | 3 Compartment Trunking |
| | 20A Double Pole Switch |
| | Consumer Unit |
| | Hand Drier |
| | Patch Panel Cabinet |
| | Distribution Board |



9. ACCESS CONTROL:

Each of the doors will have a magnetic lock and door release all controlled by a remote door release. The access panel may be finger print or card activated depending on recommendation of contractor.

10. FIRE EXTINGUISHERS AND ALARMS:

Each studio room should contain an optical smoke detector, an alarm sounder and break-glass button, all feeding into a Fire Alarm control Panel.

The contractor shall supply and install three fire extinguishers, one in each studio room.

11. AIR CONDITIONING:

There will be three high wall mounted air conditioning units, one in each studio, with an outdoor unit plus related accessories. Each unit is 18,000BTU Because the studios will be located in the basement, the condensate drainage pipe will collect into a container inside one of the rooms then a small water pump will send back the extracts outdoor.

The proposed location has an existing extraction duct whose noise will disrupt broadcasts. Works will also include removal of this duct, with support from the Parliament Electrical Technician.

12. COMMITTEE ROOMS:

There are various meeting rooms at the Parliament premises where Parliamentary Committees convene to handle legislative matters. These will be referred to as Committee Rooms and eight of them have been ear-marked as audio sources to feed into the radio system. However, these committee rooms need to be treated for sound management with executive panels but no intensive works on the walls as will be the case with the onair studios. Four sets of portable acoustics will also be supplied by the contractor. Dimensions for the rooms have been provided under "Committee Room Dimensions" on *Page 11*. The Committee Rooms include:

- i. South Committee Room
- ii. East Committee Room
- iii. Parliament Accounts Committee Room (PAC)
- iv. Speaker's Boardroom
- v. Deputy Speaker's Boardroom
- vi. Chief Whip Meeting Room
- vii. Leader of Opposition Meeting Room
- viii. Commissioner's Meeting Room

13. STUDIO CHAIRS:

The contractor will supply a total of ten orthopedic studio chairs and one set of four single leather seats units. Six studio chairs and the sofa set will be located in the Executive Onair Studio while Onair Control Room and Production studios have two chairs each. The sofa set is of four single executive seats with coffee-set.

14. STUDIO TABLES:

The contractor shall supply and install into the onair studio a regular six seater table with room for flexible chair rotation and a provision for cabling underneath. Five microphones should sit atop the table and a computer monitor with underneath keyboard on the host's position that directly faces control room. This table will have an executive thematic design on it.

The other studios will contain wall facing desks onto which about 50-80kgs of equipment rests. The desks should have cable trays and a lockable mini-rack with glass shutter underneath but no drawers.

15. PRE-BID MEETING:

For purposes of harmonization of project details and to allow potential bidders to ask questions or get clarifications on any unclear areas, a pre-bidding meeting will be organized at **Parliamentary Buildings, Plot 16-18, Parliament Avenue, Kampala, on 11th December 2017 at 11am**. At this meeting, a site tour will be conducted and thereafter, a question and answer forum. Further consultations may continue throughout the bid period until 7 days to the deadline for bid submission.

16. SUBMISSION OF BIDS:

Bids should be submitted to the address below, no later than the date and time of the deadline below. Late proposals will be rejected.

Date of deadline: **December 18, 2017**

Time of deadline: **11:00 am**

Address: **UNDP OFFICE, Plot 11, Yusuf Lule Road**

Email: tenders.kampala@undp.org

17. BID VALIDITY:

Bid validity is **120 working days** from date of bid submission.

18. SOUNDPROOFING MATERIALS AND INSTALLATION SCHEDULE:

| SOUNDPROOFING | | |
|---------------|--|------|
| | ITEMS: | QTY: |
| A | RADIO STUDIOS - (See specifications and illustrations on Page 4): | |
| 1 | Base Wall Treatment and repairs – See Page 4, Section 4 | 1 |
| 2 | Wood studs/panels – See Page 4, Section 4 | 1 |
| 3 | Absorbent foam – See Page 4, Section 4 | 3 |
| 4 | Heat absorbent materials – See Page 4, Section 4 | 3 |
| 5 | Soft Boards – See Page 4, Section 4 | 1 |
| 6 | Accessories (Screws, Glue, Sealing Rubbers, Skirting profiles) | 1 |
| 7 | Metallic U-Bars – See Page 4, Section 4 | 214 |
| 8 | Soundproof doors – See Page 5, Section 5 | 3 |
| 9 | Brick and mortar works on partition walls | 3 |
| 10 | Double-glazed windows – See Page 6, Section 6 | 2 |
| 11 | Ceiling design and installation works | 3 |
| 12 | Floor Carpet | 3 |
| 13 | Studio Lighting – See details on Page 6, Section 7 | 3 |
| 14 | Air Conditioning – See Page 8, Section 11 | 3 |
| 15 | Access Control Unit (Fingerprints or card) – See Page 7, Section 9 | 3 |
| 16 | Studio Sofa – See illustration on Page 2 and Section 13, Page 8 | 1 |
| 17 | Studio Tables – See Page 9, Section 14 | 3 |
| 18 | Electrical Installations (Sockets, Trunkings, Cabling, Sensors) | 3 |
| 19 | Fire Extinguishers – See Page 7, Section 10 | 3 |
| 20 | Alarms/smoke detector | 3 |
| 21 | Professional Acoustics (For Radio Studios) – See Page 4, Section 4 | 3 |
| | | |
| B | COMMITTEE ROOMS (8): | |
| 22 | Executive Acoustic Panels (For Committee Rooms) | 6 |
| 23 | Portable Acoustic Boards (For Committee Rooms) | 4 |
| 24 | Installation Expenses | 1 |

NOTE:

INDICATE DELIVERY TIME OF ALL MATERIALS AND COMPLETION TIME OF ALL PROJECT WORKS, READY FOR HANDOVER.

ALL POWER POINTS AND INSTALLATIONS MUST BE OF THE STANDARD 240V.

19. COMMITTEE ROOM DIMENSIONS:

These will be issued at pre-bid meeting.

20. PROJECT CONTACTS:

The point of contact for any/all consultations regarding this project shall be:

The Procurement Officer

UNDP, Plot 11, Yusuf Lule Road, Kampala.

Email: winifred.senaji@undp.org or Diana.Nabbanja@undp.org

B. DELIVERABLES / TIME FRAMES AND PAYMENTS SCHEDULE

| # | Deliverables/Duties | Estimated time of delivery from contract commencement date | Payment percentage |
|---|---|--|--------------------|
| 1 | Supply and installation of sound treatment, acoustics materials | On commencement of contract | 30% |
| 2 | Handing over site | | 70% |

Reporting Line

The Service Provider will be awarded a contract by UNDP. The execution of works will be done under the supervision of the Clerk to Parliament of Uganda who will clear deliverables. Cleared deliverables should be communicated to UNDP Country Director through Team Leader Rule of Law and Constitutional Democracy

Reporting Language

Deliverables will be prepared and submitted in English.

Title Rights

The title rights, copyrights and all other rights whatsoever nature in any material produced under the provisions of this SoW will be vested exclusively in UNDP.

C. DUTY STATION

The Service Provider will not be at UNDP office for the provision of the tasks. The duty station will be at Parliamentary Buildings, Plot 16-18, Parliament Avenue, Kampala.

QUALIFICATIONS OF THE SUCCESSFUL SERVICE PROVIDER AND VARIOUS LEVELS

Minimum qualification and experience requirements:

Corporate Competencies

- Officially registered legal entity;
- Minimum 15 years of experience in carpentry works
- Minimum 10 studios constructed by bidding entity
- At least three (3) years' experience of work in Africa.
- Must possess optimal knowledge on sound acoustics treatment i.e. suitable materials to manage sound.
- Must possess knowledge of earthing and electrical installations.

- Should have been involved in at least two (2) similar projects of construction of broadcast studios in the past five (5) years.
- Must possess knowledge in radio studio operations and workflows.
- Background in studio lighting design and implementation;

Key Personnel Qualifications:

The team should be comprised of not less than 4 experts in the following fields and include;

Master Craftsman - carpentry

- Experience of 15 years and an advanced certificate in carpentry and joinery
- Excellent spoken and written English
- Must have been involved in at least 10 studio construction projects

Electrical Technician

- Higher Diploma in electrical/electronics engineering from a recognized institution
- Must have electrical installation permit Class C
- Excellent writing and communication skills in English;
- Must have been involved in at least 5 studio electrical installations

IT Technician

- Higher Diploma in ICT or related field from a recognized institution
- Excellent writing and communication skills in English
- Must have been involved in at least 5 studio networking and installation projects of similar nature

Master Technician – Masonry

- Certificate in masonry or building construction works or related field
- At least 5 years of experience

Notes:

- Internships (paid/unpaid) are not considered professional experience.
- Obligatory military service is not considered professional experience.
- Professional experience gained in an international setting is considered international experience.
- Experience gained prior to completion of undergraduate studies is not considered professional experience.
- Documents that demonstrate participation to project cycle management are not considered an internationally recognized project management certificate.

D. TERMS OF PAYMENT AND CONDITIONS

The detailed requirements and template of the Financial Proposal are covered in Section 7 of the solicitation documents. The unit prices shall be exclusive of VAT.

E. CRITERIA FOR SELECTING THE BEST OFFER

The evaluation shall be done according to the predefined evaluation grid, and UNDP shall award contract to the best proposals (i.e. which obtain the highest cumulative score). A General guide has been provided

in DS No. 32 of the RFP Data Sheet.

The award will be done in accordance with “Combined Scoring method” procedures of UNDP – where the technical qualifications will be weighted 70%, and combined with the price offer which will be weighted 30%.

Section 4: Proposal Submission Form⁷

[insert: Location]

[insert: Date]

To: [insert: Name and Address of UNDP focal point]

Dear Sir/Madam:

We, the undersigned, hereby offer to provide professional services for [insert: title of services] in accordance with your Request for Proposal dated [insert: Date] and our Proposal. We are hereby submitting our Proposal, which includes the Technical Proposal and Financial Proposal sealed under a separate envelope.

We hereby declare that:

- a) All the information and statements made in this Proposal are true and we accept that any misrepresentation contained in it may lead to our disqualification;
- b) We are currently not on the removed or suspended vendor list of the UN or other such lists of other UN agencies, nor are we associated with, any company or individual appearing on the 1267/1989 list of the UN Security Council;
- c) We have no outstanding bankruptcy or pending litigation or any legal action that could impair our operation as a going concern; and
- d) We do not employ, nor anticipate employing, any person who is or was recently employed by the UN or UNDP.

We confirm that we have read, understood and hereby accept the Terms of Reference describing the duties and responsibilities required of us in this RFP, and the General Terms and Conditions of UNDP's Contract for Professional Services.

We agree to abide by this Proposal for [insert: period of validity as indicated in Data Sheet].

We undertake, if our Proposal is accepted, to initiate the services not later than the date indicated in the Data Sheet.

We fully understand and recognize that UNDP is not bound to accept this proposal, that we shall bear all costs associated with its preparation and submission, and that UNDP will in no case be responsible or liable for those costs, regardless of the conduct or outcome of the evaluation.

⁷ No deletion or modification may be made in this form. Any such deletion or modification may lead to the rejection of the Proposal.

We remain,

Yours sincerely,

Authorized Signature [*In full and initials*]: _____

Name and Title of Signatory: _____

Name of Firm: _____

Contact Details: _____

[please mark this letter with your corporate seal, if available]

Section 5: Documents Establishing the Eligibility and Qualifications of the Proposer

Proposer Information Form⁸

Date: *[insert date (as day, month and year) of Proposal Submission]*

RFP No.: *[insert number]*

Page _____ of _____ pages

| | | |
|---|---------------------------------|---------------------------------------|
| 1. Proposer's Legal Name <i>[insert Proposer's legal name]</i> | | |
| 2. In case of Joint Venture (JV), legal name of each party: <i>[insert legal name of each party in JV]</i> | | |
| 3. Actual or intended Country/ies of Registration/Operation: <i>[insert actual or intended Country of Registration]</i> | | |
| 4. Year of Registration: <i>[insert Proposer's year of registration]</i> | | |
| 5. Countries of Operation | 6. No. of staff in each Country | 7. Years of Operation in each Country |
| 8. Legal Address/es in Country/ies of Registration/Operation: <i>[insert Proposer's legal address in country of registration]</i> | | |
| 9. Value and Description of Top three (3) Biggest Contract for the past five (5) years | | |
| 10. Latest Credit Rating (if any) | | |
| 10. Brief description of litigation history (disputes, arbitration, claims, etc.), indicating current status and outcomes, if already resolved. | | |
| 12. Proposer's Authorized Representative Information Name: <i>[insert Authorized Representative's name]</i> Address: <i>[insert Authorized Representative's name]</i> Telephone/Fax numbers: <i>[insert Authorized Representative's name]</i> Email Address: <i>[insert Authorized Representative's name]</i> | | |
| 13. Are you in the UNPD List 1267.1989 or UN Ineligibility List? <input type="checkbox"/> YES or <input type="checkbox"/> NO | | |

⁸ *The Proposer shall fill in this Form in accordance with the instructions. Apart from providing additional information, no alterations to its format shall be permitted and no substitutions shall be accepted.*

14. Attached are copies of original documents of:

- All eligibility document requirements listed in the Data Sheet
- If Joint Venture/Consortium – copy of the Memorandum of Understanding/Agreement or Letter of Intent to form a JV/Consortium, or Registration of JV/Consortium, if registered
- If case of Government corporation or Government-owned/controlled entity, documents establishing legal and financial autonomy and compliance with commercial law.

Joint Venture Partner Information Form (if Registered)⁹

Date: *[insert date (as day, month and year) of Proposal Submission]*

RFP No.: *[insert number]*

Page _____ of _____ pages

| | | |
|--|---------------------------------|---------------------------------------|
| 1. Proposer's Legal Name: <i>[insert Proposer's legal name]</i> | | |
| 2. JV's Party legal name: <i>[insert JV's Party legal name]</i> | | |
| 3. JV's Party Country of Registration: <i>[insert JV's Party country of registration]</i> | | |
| 4. Year of Registration: <i>[insert Party's year of registration]</i> | | |
| 5. Countries of Operation | 6. No. of staff in each Country | 7. Years of Operation in each Country |
| 8. Legal Address/es in Country/ies of Registration/Operation: <i>[insert Party's legal address in country of registration]</i> | | |
| 9. Value and Description of Top three (3) Biggest Contract for the past five (5) years | | |
| 10. Latest Credit Rating (if any) | | |
| 1. Brief description of litigation history (disputes, arbitration, claims, etc.), indicating current status and outcomes, if already resolved. | | |

⁹ The Proposer shall fill in this Form in accordance with the instructions. Apart from providing additional information, No alterations to its format shall be permitted and no substitutions shall be accepted.

13. JV's Party Authorized Representative Information

Name: *[insert name of JV's Party authorized representative]*

Address: *[insert address of JV's Party authorized representative]*

Telephone/Fax numbers: *[insert telephone/fax numbers of JV's Party authorized representative]*

Email Address: *[insert email address of JV's Party authorized representative]*

14. Attached are copies of original documents of: *[check the box(es) of the attached original documents]*

- All eligibility document requirements listed in the Data Sheet
- Articles of Incorporation or Registration of firm named in 2.
- In case of government owned entity, documents establishing legal and financial autonomy and compliance with commercial law.

Section 6: Technical Proposal Form

| |
|--|
| <p>TECHNICAL PROPOSAL FORMAT</p> <p>INSERT TITLE OF THE SERVICES</p> |
|--|

Note: Technical Proposals not submitted in this format may be rejected. The financial proposal should be included in separate envelope.

| | |
|--|--|
| Name of Proposing Organization / Firm: | |
| Country of Registration: | |
| Name of Contact Person for this Proposal: | |
| Address: | |
| Phone / Fax: | |
| Email: | |

| |
|---|
| SECTION 1: EXPERTISE OF FIRM/ ORGANISATION |
| <p><i>This section should fully explain the Proposer's resources in terms of personnel and facilities necessary for the performance of this requirement. All contents of this section may be modified or expanded depending on the evaluation criteria stated in the RFP.</i></p> <p>1.1 Brief Description of Proposer as an Entity: Provide a brief description of the organization / firm submitting the proposal, its legal mandates/authorized business activities, the year and country of incorporation, types of activities undertaken, and approximate annual budget, etc. Include reference to reputation, or any history of litigation and arbitration in which the organisation / firm has been involved that could adversely affect or impact the performance of services, indicating the status/result of such litigation/arbitration.</p> <p>1.2. Financial Capacity: Provide the latest Audited Financial Statement (Income Statement and Balance Sheet) duly certified by a Public Accountant, and with authentication of receiving by the Government's Internal Revenue Authority. Include any indication of credit rating, industry rating, etc.</p> <p>1.3. Track Record and Experiences: Provide the following information regarding corporate</p> |

experience within the last five (5) years which are related or relevant to those required for this Contract.

| Name of project | Client | Contract Value | Period of activity | Types of activities undertaken | Status or Date Completed | References Contact Details (Name, Phone, Email) |
|-----------------|--------|----------------|--------------------|--------------------------------|--------------------------|---|
| | | | | | | |
| | | | | | | |

SECTION 2 - APPROACH AND IMPLEMENTATION PLAN

This section should demonstrate the Proposer's responsiveness to the TOR by identifying the specific components proposed, addressing the requirements, as specified, point by point; providing a detailed description of the essential performance characteristics proposed; and demonstrating how the proposed methodology meets or exceeds the requirements.

2.1. Approach to the Service/Work Required: Please provide a detailed description of the methodology for how the organisation/firm will achieve the Terms of Reference of the project, keeping in mind the appropriateness to local conditions and project environment.

2.2. Technical Quality Assurance Review Mechanisms: The methodology shall also include details of the Proposer's internal technical and quality assurance review mechanisms.

2.3 Implementation Timelines: The Proposer shall submit a Gantt Chart or Project Schedule indicating the detailed sequence of activities that will be undertaken and their corresponding timing.

2.4. Subcontracting: Explain whether any work would be subcontracted, to whom, how much percentage of the work, the rationale for such, and the roles of the proposed sub-contractors. Special attention should be given to providing a clear picture of the role of each entity and how everyone will function as a team.

2.5. Risks / Mitigation Measures: Please describe the potential risks for the implementation of this project that may impact achievement and timely completion of expected results as well as their quality. Describe measures that will be put in place to mitigate these risks.

2.6. Reporting and Monitoring: Please provide a brief description of the mechanisms proposed for

this project for reporting to the UNDP and partners, including a reporting schedule.

2.7. Anti-Corruption Strategy: Define the anti-corruption strategy that will be applied in this project to prevent the misuse of funds. Describe the financial controls that will be put in place.

2.8. Partnerships: Explain any partnerships with local, international or other organizations that are planned for the implementation of the project. Special attention should be given to providing a clear picture of the role of each entity and how everyone will function as a team. Letters of commitment from partners and an indication of whether some or all have successfully worked together on other previous projects is encouraged.

2.9 Statement of Full Disclosure: This is intended to disclose any potential conflict in accordance with the definition of “conflict” under Section 4 of this document, if any.

2.10 Other: Any other comments or information regarding the project approach and methodology that will be adopted.

SECTION 3: PERSONNEL

3.1 Management Structure: Describe the overall management approach toward planning and implementing this activity. Include an organization chart for the management of the project describing the relationship of key positions and designations.

3.2 Staff Time Allocation: Provide a spreadsheet will be included to show the activities of each staff member and the time allocated for his/her involvement. (Note: This *spreadsheet is crucial and no substitution of personnel will be tolerated once the contract has been awarded except in extreme circumstances and with the written approval of the UNDP. If substitution is unavoidable it will be with a person who, in the opinion of the UNDP project manager, is at least as experienced as the person being replaced, and subject to the approval of UNDP. No increase in costs will be considered as a result of any substitution.*)

3.3 Qualifications of Key Personnel. Provide the CVs for key personnel (Team Leader, Managerial and general staff) that will be provided to support the implementation of this project. CVs should demonstrate qualifications in areas relevant to the Scope of Services. Please make sure you reveal the qualifications/experience of key personnel that match the qualifications/experience listed in the relevant section of the ToR. Please use the format below:

| | | |
|--|--|--|
| Name: | | |
| Position for this Contract: | | |
| Nationality: | | |
| Contact information: | | |
| Countries of Work Experience: | | |
| Language Skills: | | |
| Educational and other Qualifications: | | |
| Summary of Experience: <i>Highlight experience in the region and on similar projects.</i> | | |
| Relevant Experience (From most recent): | | |
| Period: From – To | Name of activity/ Project/ funding organisation, if applicable: | Job Title and Activities undertaken/Description of actual role performed: |
| <i>e.g. June 2004-January 2005</i> | | |
| <i>Etc.</i> | | |
| <i>Etc.</i> | | |
| References no.1 (minimum of 3): | <i>Name Designation Organization Contact Information – Address; Phone; Email; etc.</i> | |
| Reference no.2 | <i>Name Designation</i> | |

| | |
|---|--|
| | <i>Organization</i> <i>Contact Information – Address; Phone; Email; etc.</i> |
| Reference no.3 | <i>Name</i> <i>Designation</i> <i>Organization</i> <i>Contact Information – Address; Phone; Email; etc.</i> |
| <p>Declaration:</p> <p>I confirm my intention to serve in the stated position and present availability to serve for the term of the proposed contract. I also understand that any wilful misstatement described above may lead to my disqualification, before or during my engagement.</p> <p>_____</p> <p>_____</p> <p>Signature of the Nominated Team Leader/Member Date Signed</p> | |
| | |

Section 7: Financial Proposal Form¹⁰

The Proposer is required to prepare the Financial Proposal in an envelope separate from the rest of the RFP as indicated in the Instruction to Proposers.

The Financial Proposal must provide a detailed cost breakdown. Provide separate figures for each functional grouping or category.

Any estimates for cost-reimbursable items, such as travel and out-of-pocket expenses, should be listed separately.

In case of an equipment component to the service provider, the Price Schedule should include figures for both purchase and lease/rent options. UNDP reserves the option to either lease/rent or purchase outright the equipment through the Contractor.

The format shown on the following pages is suggested for use as a guide in preparing the Financial Proposal. The format includes specific expenditures, which may or may not be required or applicable but are indicated to serve as examples.

A. Cost Breakdown per Deliverables*

| SN | Deliverables | Percentage of Total Price (Weight for payment) | Price (Lump Sum, All Inclusive) |
|----|--------------|---|---------------------------------------|
| 1 | | | |
| 4 | | | |
| 5 | | | |
| 6 | | | |
| | Total | 100% | USD |

**Basis for payment tranches*

B. Cost Breakdown by Cost Component:

The Proposers are requested to provide the cost breakdown for the above given prices for each deliverable based on the following format. UNDP shall use the cost breakdown for the price reasonability assessment purposes as well as the calculation of price in the event that both parties have agreed to add new deliverables to the scope of Services.

¹⁰ No deletion or modification may be made in this form. Any such deletion or modification may lead to the rejection of the Proposal.

| Description of Activity | Remuneration per Unit of Time (e.g., day, month, etc.) | Total Period of Engagement | No. of Personnel | Total Rate for the Period |
|-----------------------------------|--|----------------------------|------------------|---------------------------|
| I. Personnel Services | | | | |
| 1. Services from Home Office | | | | |
| a. Expertise 1 | | | | |
| b. Expertise 2 | | | | |
| 2. Services from Field Offices | | | | |
| a. Expertise 1 | | | | |
| b. Expertise 2 | | | | |
| 3. Services from Overseas | | | | |
| a. Expertise 1 | | | | |
| b. Expertise 2 | | | | |
| | | | | |
| II. Out of Pocket Expenses | | | | |
| 1. Travel Costs | | | | |
| 2. Daily Allowance | | | | |
| 3. Communications | | | | |
| 4. Reproduction | | | | |
| 5. Equipment Lease | | | | |
| 6. Others | | | | |
| III. Other Related Costs | | | | |
| | | | | |
| | | | | |
| | | | | |



UNDP
GENERAL CONDITIONS OF CONTRACT FOR SERVICES

1.0 LEGAL STATUS:

The Contractor shall be considered as having the legal status of an independent contractor vis-à-vis the United Nations Development Programme (UNDP). The Contractor's personnel and sub-contractors shall not be considered in any respect as being the employees or agents of UNDP or the United Nations.

2.0 SOURCE OF INSTRUCTIONS:

The Contractor shall neither seek nor accept instructions from any authority external to UNDP in connection with the performance of its services under this Contract. The Contractor shall refrain from any action that may adversely affect UNDP or the United Nations and shall fulfill its commitments with the fullest regard to the interests of UNDP.

3.0 CONTRACTOR'S RESPONSIBILITY FOR EMPLOYEES:

The Contractor shall be responsible for the professional and technical competence of its employees and will select, for work under this Contract, reliable individuals who will perform effectively in the implementation of this Contract, respect the local customs, and conform to a high standard of moral and ethical conduct.

4.0 ASSIGNMENT:

The Contractor shall not assign, transfer, pledge or make other disposition of this Contract or any part thereof, or any of the Contractor's rights, claims or obligations under this Contract except with the prior written consent of UNDP.

5.0 SUB-CONTRACTING:

In the event the Contractor requires the services of sub-contractors, the Contractor shall obtain the prior written approval and clearance of UNDP for all sub-contractors. The approval of UNDP of a sub-contractor shall not relieve the Contractor of any of its obligations under this Contract. The terms of any sub-contract shall be subject to and conform to the provisions of this Contract.

6.0 OFFICIALS NOT TO BENEFIT:

The Contractor warrants that no official of UNDP or the United Nations has received or will be offered by the Contractor any direct or indirect benefit arising from this Contract or the award thereof. The Contractor agrees that breach of this provision is a breach of an essential term of this Contract.

7.0 INDEMNIFICATION:

The Contractor shall indemnify, hold and save harmless, and defend, at its own expense, UNDP, its officials, agents, servants and employees from and against all suits, claims, demands, and liability of any nature or kind, including their costs and expenses, arising out of acts or omissions of the Contractor, or the Contractor's employees, officers, agents or sub-contractors, in the performance of this Contract. This provision shall extend, inter alia, to claims and liability in the nature of workmen's compensation, products liability and liability arising out of the use of patented inventions or devices, copyrighted material or other intellectual property by the Contractor, its employees, officers, agents, servants or sub-contractors. The obligations under this Article do not lapse upon termination of this Contract.

8.0 INSURANCE AND LIABILITIES TO THIRD PARTIES:

8.1 The Contractor shall provide and thereafter maintain insurance against all risks in respect of its property and any equipment used for the execution of this Contract.

8.2 The Contractor shall provide and thereafter maintain all appropriate workmen's compensation insurance, or the equivalent, with respect to its employees to cover claims for personal injury or death in connection with this Contract.

8.3 The Contractor shall also provide and thereafter maintain liability insurance in an adequate amount to cover third party claims for death or bodily injury, or loss of or damage to property, arising from or in connection with the provision of services under this Contract or the operation of any vehicles, boats, airplanes or other equipment owned or leased by the Contractor or its agents, servants, employees or sub-contractors performing work or services in connection with this Contract.

8.4 Except for the workmen's compensation insurance, the insurance policies under this Article shall:

8.4.1 Name UNDP as additional insured;

8.4.2 Include a waiver of subrogation of the Contractor's rights to the insurance carrier against the UNDP;

8.4.3 Provide that the UNDP shall receive thirty (30) days written notice from the insurers prior to any cancellation or change of coverage.

8.5 The Contractor shall, upon request, provide the UNDP with satisfactory evidence of the insurance required under this Article.

9.0 ENCUMBRANCES/LIENS:

The Contractor shall not cause or permit any lien, attachment or other encumbrance by any person to be placed on file or to remain on file in any public office or on file with the UNDP against any monies due or to become due for any work done or materials furnished under this Contract, or by reason of any other claim or demand against the Contractor.

10.0 TITLE TO EQUIPMENT: Title to any equipment and supplies that may be furnished by UNDP shall rest with UNDP and any such equipment shall be returned to UNDP at the conclusion of this Contract or when no longer needed by the Contractor. Such equipment, when returned to UNDP, shall be in the same condition as when delivered to the Contractor, subject to normal wear and tear. The Contractor shall be liable to compensate UNDP for equipment determined to be damaged or degraded beyond normal wear and tear.

11.0 COPYRIGHT, PATENTS AND OTHER PROPRIETARY RIGHTS:

11.1 Except as is otherwise expressly provided in writing in the Contract, the UNDP shall be entitled to all intellectual property and other proprietary rights including, but not limited to, patents, copyrights, and trademarks, with regard to products, processes, inventions, ideas, know-how, or documents and other materials which the Contractor has developed for the UNDP under the Contract and which bear a direct relation to or are produced or prepared or collected in consequence of, or during the course of, the performance of the Contract, and the Contractor acknowledges and agrees that such products, documents and other materials constitute works made for hire for the UNDP.

11.2 To the extent that any such intellectual property or other proprietary rights consist of any intellectual property or other proprietary rights of the Contractor: (i) that pre-existed the performance by the Contractor of its obligations under the Contract, or (ii) that the Contractor may develop or acquire, or may have developed or acquired, independently of the performance of its obligations under the Contract, the UNDP does not and shall not claim any ownership interest thereto, and the Contractor grants to the UNDP a perpetual license to use such intellectual property or other proprietary right solely for the purposes of and in accordance with the requirements of the Contract.

11.3 At the request of the UNDP; the Contractor shall take all necessary steps, execute all necessary documents and generally assist in securing such proprietary rights and transferring or licensing them to the UNDP in compliance with the requirements of the applicable law and of the Contract.

11.4 Subject to the foregoing provisions, all maps, drawings, photographs, mosaics, plans, reports, estimates, recommendations, documents, and all other data compiled by or received by the Contractor under the Contract shall be the property of the UNDP, shall be made available for use or inspection by the UNDP at reasonable times and in reasonable places, shall be treated as confidential, and shall be delivered only to UNDP authorized officials on completion of work under the Contract.

12.0 USE OF NAME, EMBLEM OR OFFICIAL SEAL OF UNDP OR THE UNITED NATIONS:

The Contractor shall not advertise or otherwise make public the fact that it is a Contractor with UNDP, nor shall the Contractor, in any manner whatsoever use the name, emblem or official seal of UNDP or THE United Nations, or any abbreviation of the name of UNDP or United Nations in connection with its business or otherwise.

13.0 CONFIDENTIAL NATURE OF DOCUMENTS AND INFORMATION:

Information and data that is considered proprietary by either Party, and that is delivered or disclosed by one Party (“Discloser”) to the other Party (“Recipient”) during the course of performance of the Contract, and that is designated as confidential (“Information”), shall be held in confidence by that Party and shall be handled as follows:

13.1 The recipient (“Recipient”) of such information shall:

13.1.1 use the same care and discretion to avoid disclosure, publication or dissemination of the Discloser’s Information as it uses with its own similar information that it does not wish to disclose, publish or disseminate; and,

13.1.2 use the Discloser’s Information solely for the purpose for which it was disclosed.

13.2 Provided that the Recipient has a written agreement with the following persons or entities requiring them to treat the Information confidential in accordance with the Contract and this Article 13, the Recipient may disclose Information to:

13.2.1 any other party with the Discloser’s prior written consent; and,

13.2.2 the Recipient’s employees, officials, representatives and agents who have a need to know such Information for purposes of performing obligations under the Contract, and employees officials, representatives and agents of any legal entity that it controls, controls it, or with which it is under common control, who have a need to know such Information for purposes of performing obligations under the Contract, provided that, for these purposes a controlled legal entity means:

13.2.2.1 a corporate entity in which the Party owns or otherwise controls, whether directly or indirectly, over fifty percent (50%) of voting shares thereof; or,

13.2.2.2 any entity over which the Party exercises effective managerial control; or,

13.2.2.3 for the UNDP, an affiliated Fund such as UNCDF, UNIFEM and UNV.

13.3 The Contractor may disclose Information to the extent required by law, provided that, subject to and without any waiver of the privileges and immunities of the United Nations, the Contractor will give the UNDP sufficient prior notice of a request for the disclosure of Information in order to allow the UNDP to have a reasonable opportunity to take protective measures or such other action as may be appropriate before any such disclosure is made.

13.4 The UNDP may disclose Information to the extent as required pursuant to the Charter of the UN, resolutions or regulations of the General Assembly, or rules promulgated by the Secretary-General.

13.5 The Recipient shall not be precluded from disclosing Information that is obtained by the Recipient from a third party without restriction, is disclosed by the Discloser to a third party without any obligation of confidentiality, is previously known by the Recipient, or at any time is developed by the Recipient completely independently of any disclosures hereunder.

13.6 These obligations and restrictions of confidentiality shall be effective during the term of the Contract, including any extension thereof, and, unless otherwise provided in the Contract, shall remain effective following any termination of the Contract.

14.0 FORCE MAJEURE; OTHER CHANGES IN CONDITIONS

14.1 In the event of and as soon as possible after the occurrence of any cause constituting force majeure, the Contractor shall give notice and full particulars in writing to the UNDP, of such occurrence or change if the Contractor is thereby rendered unable, wholly or in part, to perform its obligations and meet its responsibilities under this Contract. The Contractor shall also notify the UNDP of any other changes in conditions or the occurrence of any event that interferes or threatens to interfere with its performance of this Contract. On receipt of the notice required under this Article, the UNDP shall take such action as, in its sole discretion; it considers to be appropriate or necessary in the circumstances, including the granting to the Contractor of a reasonable extension of time in which to perform its obligations under this Contract.

14.2 If the Contractor is rendered permanently unable, wholly, or in part, by reason of force majeure to perform its obligations and meet its responsibilities under this Contract, the UNDP shall have the right to suspend or terminate this Contract on the same terms and conditions as are provided for in Article 15, "Termination", except that the period of notice shall be seven (7) days instead of thirty (30) days.

14.3 Force majeure as used in this Article means acts of God, war (whether declared or not), invasion, revolution, insurrection, or other acts of a similar nature or force.

14.4 The Contractor acknowledges and agrees that, with respect to any obligations under the Contract that the Contractor must perform in or for any areas in which the UNDP is engaged in, preparing to engage in, or disengaging from any peacekeeping, humanitarian or similar operations, any delays or failure to perform such obligations arising from or relating to harsh conditions within such areas or to any incidents of civil unrest occurring in such areas shall not, in and of itself, constitute force majeure under the Contract..

15.0 TERMINATION

15.1 Either party may terminate this Contract for cause, in whole or in part, upon thirty (30) days notice, in writing, to the other party. The initiation of arbitral proceedings in accordance with Article 16.2

("Arbitration"), below, shall not be deemed a termination of this Contract.

15.2 UNDP reserves the right to terminate without cause this Contract at any time upon 15 days prior written notice to the Contractor, in which case UNDP shall reimburse the Contractor for all reasonable costs incurred by the Contractor prior to receipt of the notice of termination.

15.3 In the event of any termination by UNDP under this Article, no payment shall be due from UNDP to the Contractor except for work and services satisfactorily performed in conformity with the express terms of this Contract.

15.4 Should the Contractor be adjudged bankrupt, or be liquidated or become insolvent, or should the Contractor make an assignment for the benefit of its creditors, or should a Receiver be appointed on account of the insolvency of the Contractor, the UNDP may, without prejudice to any other right or remedy it may have under the terms of these conditions, terminate this Contract forthwith. The Contractor shall immediately inform the UNDP of the occurrence of any of the above events.

16.0 SETTLEMENT OF DISPUTES

16.1 Amicable Settlement: The Parties shall use their best efforts to settle amicably any dispute, controversy or claim arising out of this Contract or the breach, termination or invalidity thereof. Where the parties wish to seek such an amicable settlement through conciliation, the conciliation shall take place in accordance with the UNCITRAL Conciliation Rules then obtaining, or according to such other procedure as may be agreed between the parties.

16.2 Arbitration: Any dispute, controversy, or claim between the Parties arising out of the Contract or the breach, termination, or invalidity thereof, unless settled amicably under Article 16.1, above, within sixty (60) days after receipt by one Party of the other Party's written request for such amicable settlement, shall be referred by either Party to arbitration in accordance with the UNCITRAL Arbitration Rules then obtaining. The decisions of the arbitral tribunal shall be based on general principles of international commercial law. For all evidentiary questions, the arbitral tribunal shall be guided by the Supplementary Rules Governing the Presentation and Reception of Evidence in International Commercial Arbitration of the International Bar Association, 28 May 1983 edition. The arbitral tribunal shall be empowered to order the return or destruction of goods or any property, whether tangible or intangible, or of any confidential information provided under the Contract, order the termination of the Contract, or order that any other protective measures be taken with respect to the goods, services or any other property, whether tangible or intangible, or of any confidential information provided under the Contract, as appropriate, all in accordance with the authority of the arbitral tribunal pursuant to Article 26 ("Interim Measures of Protection") and Article 32 ("Form and Effect of the Award") of the UNCITRAL Arbitration Rules. The arbitral tribunal shall have no authority to award punitive damages. In addition, unless otherwise expressly provided in the Contract, the arbitral tribunal shall have no authority to award interest in excess of the London Inter-Bank Offered Rate ("LIBOR") then prevailing, and any such interest shall be simple interest only. The Parties shall be bound by any arbitration award rendered as a result of such arbitration as the final adjudication of any such dispute, controversy, or claim.

17.0 PRIVILEGES AND IMMUNITIES:

Nothing in or relating to this Contract shall be deemed a waiver, express or implied, of any of the privileges and immunities of the United Nations, including its subsidiary organs.

18.0 TAX EXEMPTION

18.1 Section 7 of the Convention on the Privileges and Immunities of the United Nations provides, inter-alia that the United Nations, including its subsidiary organs, is exempt from all direct taxes, except charges for public utility services, and is exempt from customs duties and charges of a similar nature in respect of articles imported or exported for its official use. In the event any governmental authority refuses to recognize the United Nations exemption from such taxes, duties or charges, the Contractor shall immediately consult with the UNDP to determine a mutually acceptable procedure.

18.2 Accordingly, the Contractor authorizes UNDP to deduct from the Contractor's invoice any amount representing such taxes, duties or charges, unless the Contractor has consulted with the UNDP before the payment thereof and the UNDP has, in each instance, specifically authorized the Contractor to pay such taxes, duties or charges under protest. In that event, the Contractor shall provide the UNDP with written evidence that payment of such taxes, duties or charges has been made and appropriately authorized.

19.0 CHILD LABOUR

19.1 The Contractor represents and warrants that neither it, nor any of its suppliers is engaged in any practice inconsistent with the rights set forth in the Convention on the Rights of the Child, including Article 32 thereof, which, inter alia, requires that a child shall be protected from performing any work that is likely to be hazardous or to interfere with the child's education, or to be harmful to the child's health or physical mental, spiritual, moral or social development.

19.2 Any breach of this representation and warranty shall entitle UNDP to terminate this Contract immediately upon notice to the Contractor, at no cost to UNDP.

20.0 MINES:

20.1 The Contractor represents and warrants that neither it nor any of its suppliers is actively and directly engaged in patent activities, development, assembly, production, trade or manufacture of mines or in such activities in respect of components primarily utilized in the manufacture of Mines. The term "Mines" means those devices defined in Article 2, Paragraphs 1, 4 and 5 of Protocol II annexed to the Convention on Prohibitions and Restrictions on the Use of Certain Conventional Weapons Which May Be Deemed to Be Excessively Injurious or to Have Indiscriminate Effects of 1980.

20.2 Any breach of this representation and warranty shall entitle UNDP to terminate this Contract immediately upon notice to the Contractor, without any liability for termination charges or any other liability of any kind of UNDP.

21.0 OBSERVANCE OF THE LAW:

The Contractor shall comply with all laws, ordinances, rules, and regulations bearing upon the performance of its obligations under the terms of this Contract.

22.0 SEXUAL EXPLOITATION:

22.1 The Contractor shall take all appropriate measures to prevent sexual exploitation or abuse of anyone by it or by any of its employees or any other persons who may be engaged by the Contractor to perform any services under the Contract. For these purposes, sexual activity with any person less than eighteen years of age, regardless of any laws relating to consent, shall constitute the sexual exploitation and abuse of such person. In addition, the Contractor shall refrain from, and shall take all appropriate measures to prohibit its employees or other persons engaged by it from, exchanging any money, goods, services, offers of employment or other things of value, for sexual favors or activities, or from engaging in any sexual activities that are exploitive or degrading to any person. The Contractor acknowledges and agrees that the provisions hereof constitute an essential term of the Contract and that any breach of this representation and warranty shall entitle UNDP to terminate the Contract immediately upon notice to the Contractor, without any liability for termination charges or any other liability of any kind.

22.2 The UNDP shall not apply the foregoing standard relating to age in any case in which the Contractor's personnel or any other person who may be engaged by the Contractor to perform any services under the Contract is married to the person less than the age of eighteen years with whom sexual activity has occurred and in which such marriage is recognized as valid under the laws of the country of citizenship of such Contractor's personnel or such other person who may be engaged by the Contractor to perform any services under the Contract.

23.0 SECURITY:

23.1 The Contractor shall:

- (a) Put in place an appropriate security plan and maintain the security plan, taking into account the security situation in the country where the services are being provided;
- (b) Assume all risks and liabilities related to the Contractor's security, and the full implementation of the security plan.

23.2 UNDP reserves the right to verify whether such a plan is in place, and to suggest modifications to the plan when necessary. Failure to maintain and implement an appropriate security plan as required hereunder shall be deemed a breach of this contract. Notwithstanding the foregoing, the Contractor shall remain solely responsible for the security of its personnel and for UNDP's property in its custody as set forth in paragraph 4.1 above.

24.0 AUDITS AND INVESTIGATIONS:

24.1 Each invoice paid by UNDP shall be subject to a post-payment audit by auditors, whether internal or external, of UNDP or the authorized agents of the UNDP at any time during the term of the Contract and for a period of three (3) years following the expiration or prior termination of the Contract. The UNDP shall be entitled to a refund from the Contractor for any amounts shown by such audits to have been paid by the UNDP other than in accordance with the terms and conditions of the Contract. Should the audit

determine that any funds paid by UNDP have not been used as per contract clauses, the company shall reimburse such funds forthwith. Where the company fails to reimburse such funds, UNDP reserves the right to seek recovery and/or to take any other action as it deems necessary.

24.2 The Contractor acknowledges and agrees that, at anytime, UNDP may conduct investigations relating to any aspect of the Contract, the obligations performed under the Contract, and the operations of the Contractor generally. The right of UNDP to conduct an investigation and the Contractor's obligation to comply with such an investigation shall not lapse upon expiration or prior termination of the Contract. The Contractor shall provide its full and timely cooperation with any such inspections, post-payment audits or investigations. Such cooperation shall include, but shall not be limited to, the Contractor's obligation to make available its personnel and any documentation for such purposes and to grant to UNDP access to the Contractor's premises. The Contractor shall require its agents, including, but not limited to, the Contractor's attorneys, accountants or other advisers, to reasonably cooperate with any inspections, post-payment audits or investigations carried out by UNDP hereunder.

25.0 ANTI-TERRORISM:

25.1 The Contractor agrees to undertake all reasonable efforts to ensure that none of the UNDP funds received under this Contract are used to provide support to individuals or entities associated with terrorism and that the recipients of any amounts provided by UNDP hereunder do not appear on the list maintained by the Security Council Committee established pursuant to resolution 1267 (1999). The list can be accessed via <http://www.un.org/Docs/sc/committees/1267/1267ListEng.htm>. This provision must be included in all sub-contracts or sub-agreements entered under this Contract.

26.0 AUTHORITY TO MODIFY:

Pursuant to the Financial Regulations and Rules of UNDP, only the UNDP Authorized Official possesses the authority to agree on behalf of UNDP to any modification of or change in this Agreement, to a waiver of any of its provisions or to any additional contractual relationship of any kind with the Contractor. Accordingly, no modification or change in this Contract shall be valid and enforceable against UNDP unless provided by an amendment to this Agreement signed by the Contractor and jointly by the UNDP Authorized Official.
